

# Color Monitor

---

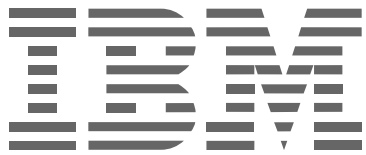

## P96

---

Operating Instructions	EN
Mode d'emploi	F
Bedienungsanleitung	D
Manual de instrucciones	ES
Istruzioni per l'uso	I





To avoid shock hazard:

- Do not remove the covers.
- Do not operate this product unless the stand is attached.
- Do not connect or disconnect this product during an electrical storm.
- The power cord plug must be connected to a properly wired and grounded power outlet.
- Any equipment to which this product will be attached must also be connected to properly wired and grounded power outlets.
- To isolate the monitor from the electrical supply, you must remove the plug from the power outlet. The power outlet should be easily accessible.

**Handling:**

- Your color monitor is heavy, so handle it with care. IBM recommends that this monitor is moved or lifted by two people.



Pour éviter les risques d'électrocution :

- Ne retirez pas les capots du moniteur.
- N'utilisez pas ce produit si le socle n'est pas fixé.
- Ne connectez, ni ne déconnectez ce produit pendant un orage.
- Le câble d'alimentation doit être connecté à une prise électrique correctement mise à la terre et en bon état de marche.
- Tout équipement auquel ce produit est relié doit être également connecté à une prise correctement mise à la terre et en bon état de marche.
- Pour isoler le moniteur de la source d'alimentation électrique, vous devez le débrancher de la prise électrique. Cette prise doit être facile d'accès

**Manutention:**

- Votre moniteur couleurs est lourd et doit donc être manipulé avec soin. IBM vous conseille de le déplacer ou de le porter à deux.



Um die Gefahr eines elektrischen Schlags zu vermeiden, folgendes beachten:

- Unter keinen Umständen die Abdeckungen abnehmen.
- Das Produkt nicht in Betrieb nehmen, wenn der Sockel nicht montiert ist.
- Das Gerät nicht während eines Gewitters an eine Steckdose anschließen oder von ihr trennen.
- Das Netzkabel ist an eine ordnungsgemäß verdrahtete und geerdete Steckdose anzuschließen.
- Jedes Gerät, mit dem dieses Produkt verbunden wird, muß ebenfalls an eine ordnungsgemäß verdrahtete und geerdete Steckdose angeschlossen werden.
- Um den Monitor von der Stromversorgung zu trennen, muß der Stecker aus der Steckdose gezogen werden. Die Steckdose sollte leicht zugänglich sein.

**Handhabungshinweis:**

- Ihr Farbbildschirm ist schwer. Sie sollten daher beim Transport vorsichtig vorgehen. IBM empfiehlt Ihnen, den Bildschirm zu zweit anzuheben bzw. zu tragen.



Ga als volgt te werk om het gevaar van een elektrische schok te voorkomen:

- Verwijder in geen enkel geval de kap.
- Stel dit produkt alleen in werking als de voet is bevestigd.
- Sluit dit apparaat niet aan op, of verbreek de aansluiting van dit apparaat niet van een contactdoos tijdens onweer.
- Het netsnoer moet worden aangesloten op een geaarde contactdoos met correcte bedrading.
- Ook alle apparatuur waarop dit produkt wordt aangesloten moet zijn aangesloten op een contactdoos met correcte bedrading.
- Om het beeldscherm te ontkoppelen van de netvoeding, dient u de stekker uit de contactdoos te trekken. De contactdoos dient goed toegankelijk te zijn.

**Verplaatsing:**

- Uw kleurenmonitor is zwaar, ga er dus voorzichtig mee om. IBM raadt aan dat het tillen of verplaatsen ervan door twee mensen gebeurt.



Para evitar riesgos de descargas eléctricas:

- No retire bajo ningún concepto las cubiertas.
- No maneje el monitor sin antes acoplar el soporte.
- No conecte ni desconecte el equipo de una toma de alimentación durante una tormenta eléctrica.
- El cable de alimentación debe estar conectado a un enchufe debidamente cableado y con toma de tierra.
- Cualquier equipo al que se vaya a conectar este producto también debe estar conectado a tomas de alimentación cableadas y conectadas a tierra correctamente.
- Para aislar el monitor del suministro eléctrico, debe retirar el enchufe de la toma de alimentación. Esta toma deberá ser de fácil acceso.

**Movimentazione del monitor:**

- Il monitor a colori è pesante, si consiglia quindi di maneggiarlo con attenzione. IBM raccomanda che il monitor venga mosso o sollevato da due persone.

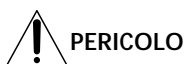

Per evitare il rischio di scariche elettriche:

- Non rimuovere nessuna parte del telaio.
- Non accendere il prodotto se il piedistallo non è stato montato.
- Non collegare o scollegare il prodotto nel corso di un temporale.
- La spina del cavo di alimentazione deve essere collegata ad una presa di corrente con messa a terra, installata in maniera appropriata.
- Le apparecchiature a cui il prodotto viene attaccato devono essere collegate a prese di corrente con messa a terra, installate in maniera appropriata.
- Per isolare il monitor dalla corrente elettrica, staccare la spina dalla presa di alimentazione, che deve essere facilmente accessibile.

**Manipulación:**

- El monitor de color es pesado, por lo que debe manipularlo con cuidado. IBM recomienda moverlo con la ayuda de dos personas.



Para evitar o perigo de choques eléctricos:

- Não retire as coberturas.
- Não utilize este produto antes de montar a base.
- Não ligue nem desligue este produto durante uma tempestade eléctrica.
- O cabo de alimentação deve ser ligado a uma tomada eléctrica devidamente ligada à terra.
- Qualquer equipamento ligado a este produto deve estar ligado a tomadas eléctricas devidamente ligadas à terra.
- Para isolar o monitor da fonte de alimentação, retire a ficha do cabo de alimentação da tomada eléctrica. A tomada eléctrica deve ser de fácil acesso.

**Manuseio:**

- Seu monitor colorido é pesado, então manuseie-o com cuidado. A IBM recomenda que o monitor seja movido ou carregado por duas pessoas.



Sådan undgår du elektrisk stød:

- Kabinettet må under ingen omstændigheder fjernes.
- Undgå at anvende dette produkt, uden at vippe/drejefoden er monteret.
- Undgå at tilslutte eller frakoble dette produkt i tordenvejr.
- Netledningen skal være tilsluttet en korrekt jordet stikkontakt med korrekt ledningsføring.
- Alt udstyr, som tilsluttes dette produkt, skal også være tilsluttet korrekt jordede stikkontakter med korrekt ledningsføring.
- For at isolere skærmen fra strømforsyningen, skal stikket tages ud af stikkontakten. Stikkontakten bør være let tilgængelig.

**Håndtering:**

- Farveskærmen er tung, så den skal håndteres forsigtigt. IBM anbefaler, at skærmen flyttes eller løftes af to personer.



## FARE

Slik unngår du fare for elektrisk støt:

- Ikke ta av dekslene.
- Ikke bruk produktet dersom sokkelen ikke er montert.
- Ikke koble produktet til eller fra under tordenvær.
- Pluggen på strømledningen må kobles til korrekt montert og jordet strømuttak.
- Utstyr som dette produktet eventuelt blir koblet til, må også kobles til korrekt montert og jordet strømuttak.
- For å isolere skjermen fra strømkilden må du ta ut pluggen fra strømuttaket. Strømuttaket bør være lett tilgjengelig.

**Käsittely:**

- Värinäyttö on painava, joten käsittele sitä varoen. IBM suosittelee, että kaksi henkilöä siirtää tai nostaa sitä.



## Varning - livsfara

För att undvika risk för elektriska stötar måste du tänka på följande:

- Ta inte bort några skyddskåpor.
- Använd inte den här produkten innan du har satt fast stativet.
- Anslut inte produkten till ett eluttag under åskväder. Koppla inte heller ur produkten från ett eluttag under åskväder.
- Strömkabeln måste anslutas till ett felfritt och jordat uttag.
- All utrustning som den här produkten kopplas till måste också anslutas till felfria och jordade uttag.
- För att bryta strömmen till bildskärmen måste du dra ut kontakten. Väggtaget bör vara lätt att komma åt.

**Hantering:**

- Färgskärmen är tung och bör därför hanteras försiktigt. IBM rekommenderar att den flyttas eller lyfts av två personer.



## VAARA

Sähköiskun vaaran välttämiseksi:

- Älä avaa laitteen kansia missään tilanteessa.
- Älä käytä laitetta, ellei jalustaa ole kiinnitetty.
- Älä kytke laitetta pistorasiaan tai irrota sitä pistorasiasta ukonilman aikana.
- Virtajohto on kytkettävä asianmukaisesti johdotettuun ja maadoitettuun pistorasiaan.
- Kaikki muutkin laitteet, joihin tämä tuote on liitetty, on kytkettävä asianmukaisesti johdotettuihin pistorasioihin.
- Kun haluat erottaa näyttimen sähköverkosta, sinun pitää irrottaa sen verkkojohto pistorasiasta. Pistorasian pitäisi olla mahdollisimman lähellä näyttintä ja vaivattomasti käsillä.

**Håndtering:**

- Värimonitorinne on painava, joten käsitelkää sitä varovasti. IBM suosittelee, että monitorin siirtämiseen tai kantamiseen käytetään kahta henkilöä.



## ΚΙΝΔΥΝΟΣ

Για την αποφυγή κινδύνου ηλεκτροπληξίας:

- Μην αφαιρείτε τα καλύμματα.
- Μη θέτετε το προϊόν αυτό σε λειτουργία χωρίς να είναι στερεωμένη η βάση του.
- Μη συνδέετε ή αποσυνδέετε το προϊόν αυτό κατά τη διάρκεια ηλεκτροθύελλας.
- Το φως του καλωδίου ρευματολήπτη πρέπει να συνδεθεί σε μια πρίζα με σωστή καλωδίωση και γείωση.
- Κάθε συσκευή στην οποία συνδεθεί αυτό το προϊόν πρέπει επίσης να συνδεθεί σε πρίζα με σωστή καλωδίωση και γείωση.
- Για να απομονώσετε την οθόνη από την παροχή ρεύματος, πρέπει να αφαιρέσετε το φως από την πρίζα. Η πρίζα πρέπει να είναι σε σημείο εύκολα προσβάσιμο.

**Χειρισμός:**

- Η έγχρωμη οθόνη σας είναι βαριά, γι' αυτό χειριστείτε την με προσοχή. Η IBM συνιστά η οθόνη να μεταφέρεται ή να σηκώνεται από δύο άτομα.



Elektrik çarpması tehlikesinden kaçınmak için:

- Kapakları çıkarmayınız.
- Bu cihazı kaidesine takılı durumda değilken çalıştırmayınız.
- Bu cihazı elektriksel fırtına sırasında prize takmayınız veya prizden çıkarmayınız.
- Elektrik kablosunun fişi, elektrik ve toprak bağlantıları usulüne uygun olarak yapılmış bir prize takılmalıdır.
- Bu cihazın bağlanacağı diğer tüm cihazlar da elektrik ve toprak bağlantıları usulüne uygun olarak yapılmış prize takılmış olmalıdır.
- Monitörün elektrikle bağlantısını kesmek için fişini prizden çekmeniz gereklidir. Priz, kolayca erişilebilecek bir yerde olmalıdır.

**Kaldırma:**

- Renkli monitörünüz ağırdır; kaldırırken dikkatli olunuz. IBM, monitörün iki kişi tarafından taşınmasını veya kaldırılmasını tavsiye etmektedir.

# English

# Edition 1

This publication could contain technical inaccuracies or typographical errors. Changes are made periodically to the information herein; these changes will be made in later editions. IBM may make improvements and/or changes in the product(s) and/or program(s) at any time.

It is possible that this publication may contain reference to, or information about, IBM products (machines and programs), programming, or services that are not announced in your country.

Requests for copies of this publication and for technical information about IBM products should be made to your IBM Authorized Dealer or IBM Retailer.

No part of this publication may be reproduced or distributed in any form or by any means without prior permission in writing from the International Business Machines Corporation.

References in this publication to IBM products, programs, or services do not imply that IBM intends to make these available in all countries in which IBM operates. Any reference to an IBM product, program or service is not intended to state or imply that only IBM's product, program, or service may be used. Any functionally equivalent product, program, or service that does not infringe any of IBM's intellectual property rights or other legally protectable rights may be used instead of the IBM product, program, or service. Evaluation and verification of operation in conjunction with other products, programs, or services, except those expressly designated by IBM, are the user's responsibility.

IBM may have patents or pending patent applications covering subject matter in this document. The furnishing of this document does not give you any license to these patents.

## Trademarks

The following terms, used in this publication, are trademarks or service marks of the IBM Corporation in the United States or other countries:

**IBM VGA HelpCenter**

- ENERGY STAR is a U.S. registered mark.
- Trinitron® is a registered trademark of Sony Corporation.
- DDC™ is a trademark of the Video Electronics Standard Association.
- VESA is a trademark of Video Electronics Standard Association.
- All other product names mentioned herein may be the trademarks or registered trademarks of their respective companies.
- Furthermore, "™" and "®" are not mentioned in each case in this manual.

© Copyright International Business Machines Corporation 1999.  
All rights reserved.



# TABLE OF CONTENTS







---

## Getting started

Precautions .....	2
Identifying Parts and Controls .....	3
Setup .....	4
Selecting the Input Signal .....	5
Automatically Sizing and Centering the Picture .....	5

---

## Customizing Your Monitor

Selecting the On-screen Display Language .....	6
Adjusting the Picture Brightness and Contrast .....	6
Introducing the On-screen Display System .....	6
Using the SIZE/CENTER  On-screen Display .....	7
Using the GEOMETRY  On-screen Display .....	8
Using the COLOR  On-screen Display .....	9
Using the CONVERGENCE  On-screen Display .....	10
Using the LANGUAGE  On-screen Display .....	11
Using the OPTION  On-screen Display .....	11
Using the HELP  On-screen Display .....	14
Resetting the Adjustments .....	15

EN

---

## Technical Features

Power Saving Function .....	16
Damper Wires .....	16
Plug & Play .....	16
Preset Modes .....	17
Displaying the Monitor's Information .....	17

---

## Additional Information

Warning Messages .....	17
Troubleshooting .....	18
Self-diagnosis Function .....	20
Specifications .....	20

## Precautions

### Installation

- Prevent internal heat build-up by allowing adequate air circulation. Do not place the monitor on surfaces (rugs, blankets, etc.) or near materials (curtains, draperies) that may block the ventilation holes.
- Do not install the monitor near heat sources such as radiators or air ducts, or in a place subject to direct sunlight, excessive dust, mechanical vibration, or shock.
- Do not place the monitor near equipment which generates magnetism, such as a transformer or high voltage power lines.

### Maintenance

- Clean the cabinet, panel and controls with a soft cloth lightly moistened with a mild detergent solution. Do not use any type of abrasive pad, scouring powder, or solvent, such as alcohol or benzine.
- Do not rub, touch, or tap the surface of the screen with sharp or abrasive items such as a ballpoint pen or screwdriver. This type of contact may result in a scratched picture tube.
- Clean the screen with a soft cloth. If you use a glass cleaning liquid, do not use any type of cleaner containing an anti-static solution or similar additive as this may scratch the screen's coating.

### Transportation

When you transport this monitor for repair or shipment, use the original carton and packing materials.

## Use of the Tilt-Swivel

This monitor can be adjusted within the angles shown below. To find the center of the monitor's turning radius, align the center of the monitor's screen with the centering dots on the stand.

Hold the monitor at the bottom with both hands when you turn it horizontally or vertically. Be careful not to pinch your fingers at the back of the monitor when you tilt the monitor up vertically.

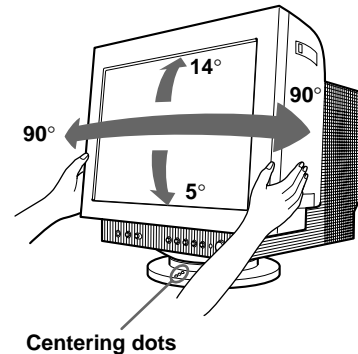

### Note

Do not remove the tilt-swivel base from the monitor.

## Warning on power connection

- Use an appropriate power cord for your local power supply.

Examples of plug types:

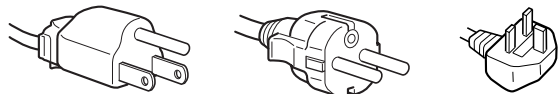

for 100 to 120 V AC    for 200 to 240 V AC    for 240 V AC only

- Before disconnecting the power cord, wait at least 30 seconds after turning off the power to allow the static electricity on the CRT display surface to discharge.
- After the power has been turned on, the CRT is demagnetized (degaussed) for about 5 seconds. This generates a strong magnetic field around the metal frame, which may affect the data stored on magnetic tapes and disks near the bezel. Place magnetic recording equipment, tapes, and disks away from this monitor.

The equipment should be installed near an easily accessible electrical outlet.

## Identifying Parts and Controls

See the pages in parentheses for further details.

### Front

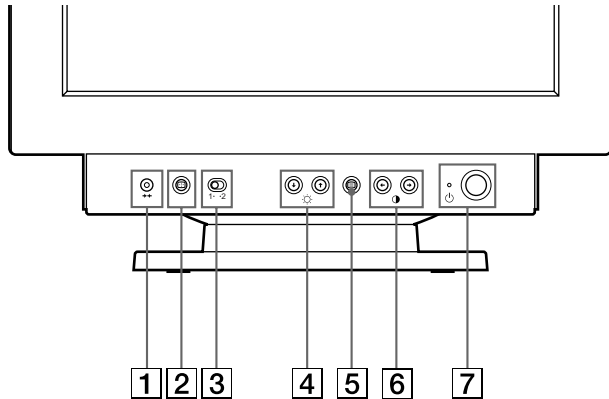

- 1** →← (reset) button (page 15)  
Resets the adjustments to the factory settings.
- 2** ◻ (auto sizing and centering) button (page 5)  
This button automatically adjusts the size and centering of the picture.
- 3** Input 1-2 switch (pages 5)  
This switch selects the INPUT 1 (Video input 1 connector) or INPUT 2 (Video input 2 connector).
- 4** ☀ (brightness) down and up (↓/↑) buttons (pages 6 – 15)  
Adjust the picture brightness.  
Function as the (↓/↑) buttons when adjusting other items.
- 5** ≡ (menu) button (pages 6 – 15, 17)  
Displays the MENU OSD.
- 6** ○ (contrast) left and right (←/→) buttons (pages 6 – 15, 20)  
Adjust the contrast.  
Function as the (←/→) buttons when adjusting other items.
- 7** ⏻ (power) switch and indicator (pages 16, 20)  
Turns the monitor on or off.  
The power indicator lights up in green when the monitor is turned on, and either flashes in green and orange, or lights up in orange when the monitor is in power saving mode.

### Rear

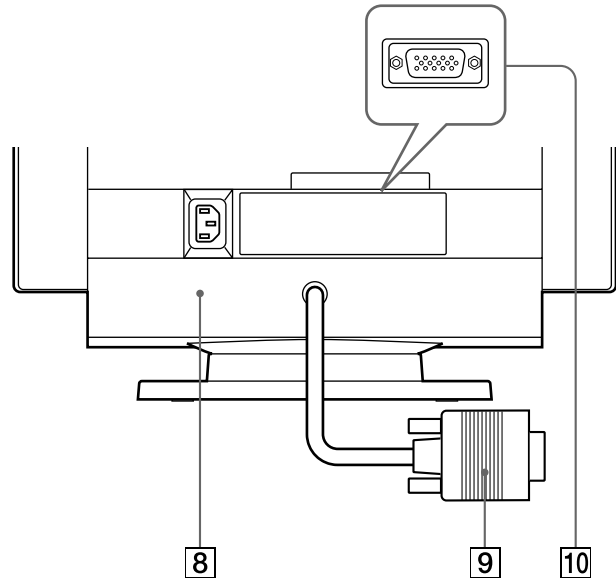

- 8** AC IN connector (page 4)  
Provides AC power to the monitor.
- 9** Video input 1 connector (HD15) (page 4)  
Inputs RGB video signals (0.700 Vp-p, positive) and SYNC signals.

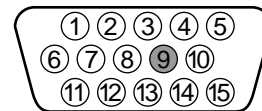

Pin No.	Signal	Pin No.	Signal
1	Red	8	Blue Ground
2	Green (Sync on Green)	9	—
3	Blue	10	Ground
4	ID (Ground)	11	ID (Ground)
5	DDC Ground*	12	Bi-Directional Data (SDA)*
6	Red Ground	13	H. Sync
7	Green Ground	14	V. Sync
		15	Data Clock(SCL)*

\* Display Data Channel (DDC) Standard of VESA

- 10** Video input 2 connector (HD15) (page 4)  
Inputs RGB video signals (0.700 Vp-p, positive) and SYNC signals.  
See the above table for the pin assignment.

## Setup

This monitor works with platforms running at horizontal frequencies between 30 and 107kHz.

### Step 1: Make sure the computer and monitor are switched off

### Step 2: Connect the monitor to the computer

Connect the video signal cable to the video output of the computer.

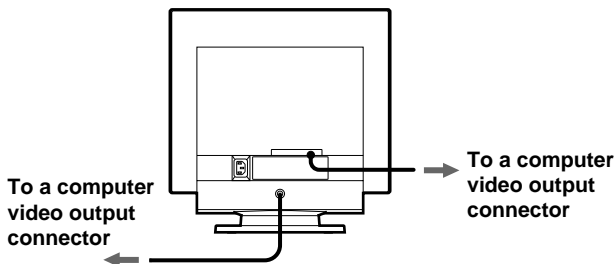

#### Note

Do not short the pins of the video signal cable.

### Step 3: Connect the power cord

With the monitor switched off, connect one end of the proper power cord for your local supply to the monitor and the other end to a power outlet.

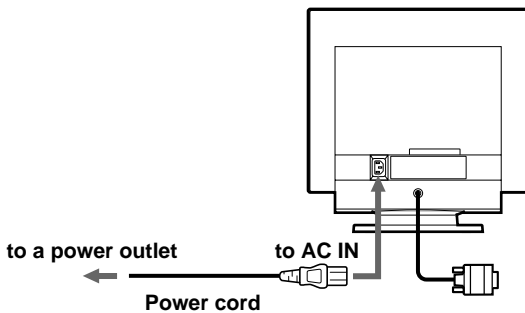

### Step 4: Turn on the monitor and computer

### Step 5: Adjust the monitor's controls according to your personal preference

The installation of your monitor is complete.

#### Note

If no picture appears on the screen and "OUT OF SCAN RANGE" or "MONITOR IS IN POWER SAVE MODE" appears on the screen, see "Warning Messages" on page 17.

## Workplace Preparation

### Positioning the Monitor

Choose a suitable place to position the monitor where it is not near fluorescent desk lighting or any equipment that produces magnetic fields that could cause interference. Ensure that the furniture or equipment can support the weight of the monitor. Allow at least 2 inches (50mm) ventilation space around the monitor.

### Height

The monitor should be positioned so that the top of the screen is slightly below your eye level when you sit at your workstation.

### Orientation

Choose a position that gives the least reflection from lights and windows, usually at a right angle to any windows. The monitor should be positioned directly in front of you so that you do not have to twist your body. Tilt the monitor to a comfortable viewing angle.

## Working Practices

### Rest

Take regular breaks. Vary your posture, and stand up and stretch occasionally as prolonged use of computer workstations can be tiring.

### Back

You should sit back in the chair and use the backrest.

### Hands

Use a light touch on the keyboard, keeping your hands and fingers relaxed. Allow a space in front of the keyboard to rest your wrists when not typing. Consider using a wristpad.

### Eyesight

Working with monitors, in common with any kind of prolonged close work, can be visually demanding. Look away from the screen periodically and have your eyesight checked regularly.

### Screen settings

Set the screen brightness and contrast to a comfortable level. You may have to adjust this as the lighting changes during the day. Many application programs let you select color combinations which can help you to view in comfort.

## Selecting the Input Signal

You can connect two computers to this monitor using the video input 1 and video input 2 connectors. To select one of the two computers, use the Input 1-2 switch.

Move the Input 1-2 switch.

The selected connector appears on the screen for 3 seconds.



“INPUT 1” (video input 1 connector) or “INPUT 2” (video input 2 connector) appears on the screen.

### Note

If no signal is input to the selected connector, NO INPUT SIGNAL appears on the screen. After a few seconds, the monitor enters the power saving mode. If this happens, switch to the other connector.

## Automatically Sizing and Centering the Picture

EN

You can easily adjust the picture to fill the screen by pressing the  (auto sizing and centering) button.

Press the  button.

The picture automatically fills the screen.

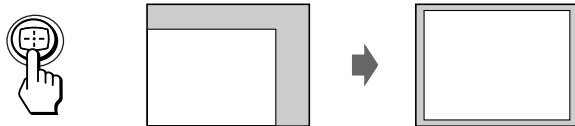

### Notes

- This function is intended for use with a computer that provides a full-screen picture. It may not work properly if the background color is dark or if the input picture does not fill the screen to the edges.
- Pictures with an aspect ratio of 5:4 (resolution: 1280 × 1024) are displayed at their actual resolution and do not fill the screen to the edges.
- The displayed image moves for a few seconds when the  button is pressed. This is not a malfunction.

## Before adjusting



- Connect the monitor and the computer, and turn them on.

## Selecting the On-screen Display Language

If you need to change the OSD language, see “Using the LANGUAGE  On-screen Display” on page 11. The default setting is English.

## Adjusting the Picture Brightness and Contrast

Once the setting is adjusted, it will be stored in memory for all input signals received.

- 1 Press the  (brightness)  $\downarrow/\uparrow$  or  (contrast)  $\leftarrow/\rightarrow$  buttons.  
The BRIGHTNESS/CONTRAST OSD appears.



- 2 For brightness adjustment  
Press the   $\downarrow/\uparrow$  buttons.

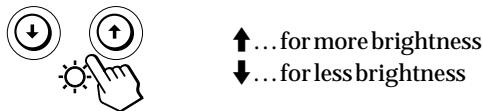

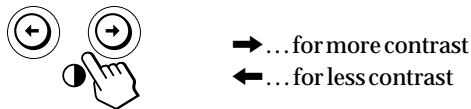

For contrast adjustment  
Press the   $\leftarrow/\rightarrow$  buttons.



The OSD automatically disappears after about 3 seconds.

To reset, press the  $\rightarrow\leftarrow$  (reset) button while the OSD is on. The brightness and contrast are both reset to the factory settings.

If you set sRGB to “ON” on the color setting, the brightness () and contrast () are automatically set to “31” and “85” respectively.

For more information about sRGB, see “Using the COLOR  On-screen Display” on page 9.

## Introducing the On-screen Display System

Most adjustments are made using the MENU OSD.

### MENU OSD

Press the  button to display the MENU OSD. This MENU OSD contains links to the other OSDs described below.

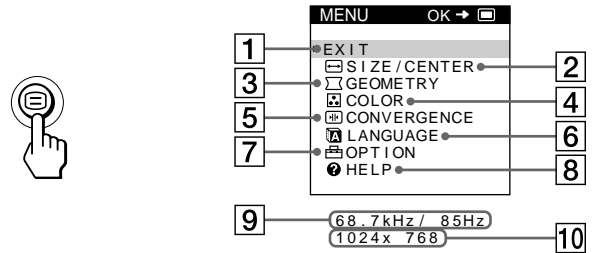



- 1 **EXIT**  
Closes the MENU OSD.
- 2 **SIZE/CENTER**  
Displays the SIZE/CENTER OSD for adjusting the picture's size, centering, or zoom.
- 3 **GEOMETRY**  
Displays the GEOMETRY OSD for adjusting the picture rotation and pincushion, etc.
- 4 **COLOR**  
Displays the COLOR OSD for adjusting the color temperature.
- 5 **CONVERGENCE**  
Displays the CONVERGENCE OSD for adjusting the picture's horizontal and vertical convergence.
- 6 **LANGUAGE**  
Displays the LANGUAGE OSD for selecting the language.
- 7 **OPTION**  
Displays the OPTION OSD for adjusting the OSD position, degaussing the screen, etc.
- 8 **HELP**  
Displays the HELP OSD for viewing helpful hints and information about this monitor.
- 9 **The horizontal and vertical frequencies of the current input signal**  
The horizontal and vertical frequencies of the current input signal are displayed.
- 10 **The resolution of the current input signal**  
If the signal matches one of this monitor's factory preset modes, the resolution is displayed.

## Using the SIZE/CENTER On-screen Display



The SIZE/CENTER settings allow you to adjust the picture's size, centering, or zoom. Once the setting is adjusted, it will be stored in memory for the current input signal.

- 1 Press the  button.  
The MENU OSD appears.



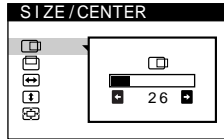
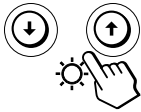



- 2 Press the / buttons to select "SIZE/CENTER" and press the  button again.  
The SIZE/CENTER OSD appears.

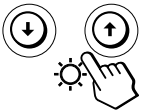







- 3 Press the / buttons to select the item you want to adjust.

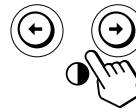



Select	To
 (Horizontal Centering)	adjust the horizontal centering of the picture
 (Vertical Centering)	adjust the vertical centering of the picture
 (Horizontal Sizing)	adjust the horizontal size of the picture
 (Vertical Sizing)	adjust the vertical size of the picture
 (Zoom)	enlarge or reduce the picture

- 4 Press the / buttons to adjust the settings.



Select	To
 (Horizontal Centering)	➡ ... to move the picture right ⬅ ... to move the picture left
 (Vertical Centering)	➡ ... to move the picture up ⬅ ... to move the picture down
 (Horizontal Sizing)	➡ ... to increase picture width ⬅ ... to decrease picture width
 (Vertical Sizing)	➡ ... to increase picture height ⬅ ... to decrease picture height
 (Zoom)	➡ ... to enlarge the picture ⬅ ... to reduce the picture

Press the  button once to return to the MENU OSD, and twice to return to normal viewing. If no buttons are pressed, the OSD closes automatically after about 30 seconds.

To reset, press the  (reset) button while the OSD is on. The selected item is reset to the factory setting.

### Note

The  (Zoom) adjustment stops when the horizontal or vertical size reaches its maximum or minimum value. The horizontal adjustment value is not displayed in the menu.



## Using the GEOMETRY On-screen Display

The GEOMETRY settings allow you to adjust the shape and orientation of the picture.



Once the □ (Rotation) is adjusted, it will be stored in memory for all input signals received. All other adjustments will be stored in memory for the current input signal.

- 1 Press the  button.  
The MENU OSD appears.



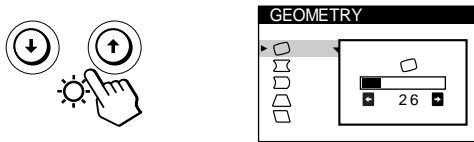



- 2 Press the / buttons to select "GEOMETRY" and press the  button again.  
The GEOMETRY OSD appears.

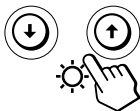









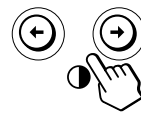

















- 3 Press the / buttons to select the item you want to adjust.





Select	To
 (Rotation)	adjust the picture rotation
 (Pincushion)	adjust the picture sides
 (Pin Balance)	adjust the picture side balance
 (Keystone)	adjust the picture width
 (Key Balance)	adjust the picture shape balance

- 4 Press the / buttons to adjust the settings.



For	Press
 (Rotation)	<p> ... to rotate the picture clockwise</p>  <p> ... to rotate the picture counterclockwise</p> 
 (Pincushion)	<p> ... to expand the picture sides</p>  <p> ... to contract the picture sides</p> 
 (Pin Balance)	<p> ... to expand the picture sides to the right</p>  <p> ... to expand the picture sides to the left</p> 
 (Keystone)	<p> ... to increase the picture width at the top</p>  <p> ... to decrease the picture width at the top</p> 
 (Key Balance)	<p> ... to move the top of the picture to the right</p>  <p> ... to move the top of the picture to the left</p> 

Press the  button once to return to the MENU OSD, and twice to return to normal viewing. If no buttons are pressed, the OSD closes automatically after about 30 seconds.

To reset, press the  (reset) button while the OSD is on. The selected item is reset to the factory setting.





## Using the COLOR On-screen Display

You can change the monitor's color temperature. For example, you can adjust or change the colors of a picture on the screen to match the actual colors of a printed picture. Once the setting is adjusted, it will be stored in memory for all input signals received.

1 Press the  button.



2 Press the  buttons to select " COLOR" and press the  button again.

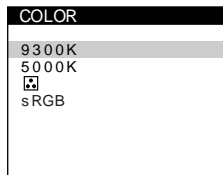
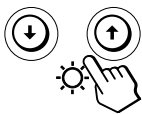

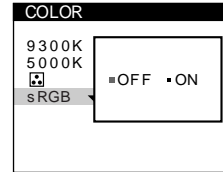
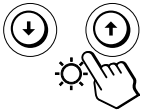

3 Press the  buttons to select the color temperature.

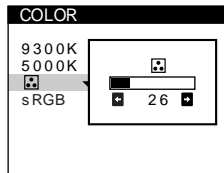
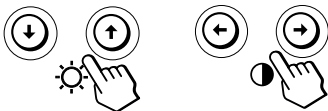

Selecting your own color temperature between 9,300K and 5,000K

Use the  buttons to select the color temperature.







Press the  button once to return to the MENU OSD, and twice to return to normal viewing. If no buttons are pressed, the OSD closes automatically after about 30 seconds.



To reset, press the  (reset) button while the OSD is on. The selected color temperature is reset to the factory settings.

## sRGB Mode

The sRGB color setting is an industry standard color space protocol designed to correlate the displayed and printed colors of sRGB compliant computer products. To adjust the colors to the sRGB profile, simply set the sRGB "ON" in the COLOR menu.

However, in order to display the sRGB colors correctly ( $\gamma = 2.2$ , 6500K), you must set your computer to the sRGB profile.

When you set sRGB to "ON" the brightness () and contrast () are automatically set to "31" and "85" respectively. If you change the brightness () and contrast () sRGB setting is changed to "OFF".

For information on how to change the brightness () and contrast () see page 6.

### Note

Your computer and other connected products (such as a printer), must be sRGB compliant.

## Using the CONVERGENCE On-screen Display



The CONVERGENCE settings allow you to adjust the quality of the picture by controlling the convergence. The convergence refers to the alignment of the red, green, and blue color signals.

If you see red or blue shadows around letters or lines, adjust the convergence.

Once the setting is adjusted, it will be stored in memory for all input signals received.

**1** Press the  button.



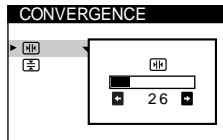
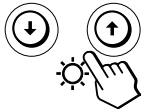

**2** Press the  buttons to select "CONVERGENCE" and press the  button again.



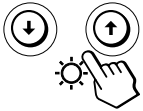





**3** Press the  buttons to select the item you want to adjust.

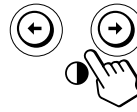



Select	To
	latnzirh eht tsujd ecnegrewo
	lacitrev eht tsujda

**4** Press the  buttons to adjust the settings.



For	Press
 (Horizontal Convergence)	 
 (Vertical Convergence)	 

Press the  button once to return to the MENU OSD, and twice to return to normal viewing. If no buttons are pressed, the OSD closes automatically after about 30 seconds.



To reset, press the  (reset) button while the OSD is on. The selected item is reset to the factory setting.

## Using the LANGUAGE On-screen Display



English, French, German, Spanish, Italian, Dutch, Swedish, Russian, and Japanese versions of the OSDs are available.

- 1 Press the  button.

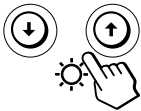

- 2 Press the   buttons to select "LANGUAGE" and press the  button again.



- 3 Press the   buttons to select the desired language.

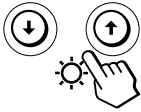

## Using the OPTION On-screen Display



The OPTION OSD allows you to manually degauss the screen, adjust the moire cancellation level, and adjust the OSD position. It also allows you to lock the controls.

### Degaussing the screen



The monitor screen is automatically degaussed (demagnetized) when the power is turned on. You can also manually degauss the monitor.

- 1 Press the  button.

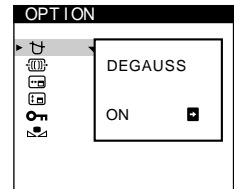
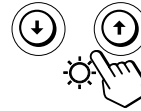

- 2 Press the   buttons to select "OPTION" and press the  button again.



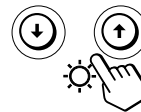

- 3 Press the   buttons to select "DEGAUSS."

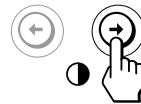

- 4 Press the  button.



Press the  button once to return to the MENU OSD, and twice to return to normal viewing. If no buttons are pressed, the OSD closes automatically after about 30 seconds.

To reset to English, press the  (reset) button while the OSD is on.

If you need to degauss the screen a second time, wait for at least 20 minutes before repeating the steps above.

Press the  button once to return to the MENU OSD, and twice to return to normal viewing. If no buttons are pressed, the OSD closes automatically after about 30 seconds.





# Customizing Your Monitor

## Adjusting the moire



If elliptical or wavy patterns appear on the screen, adjust the moire cancellation level.

- 1 Press the  button.  
The MENU OSD appears.



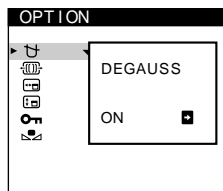
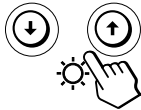

- 2 Press the / buttons to select " OPTION" and press the  button again.  
The OPTION OSD appears.

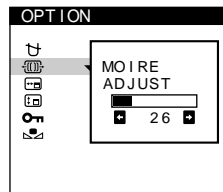
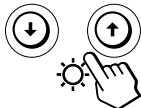

- 3 Press the / buttons to select " MOIRE\* ADJUST."



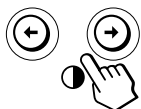

- 4 Press the / buttons to adjust the amount of moire cancellation until the moire effect is at a minimum.

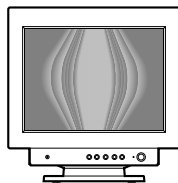

\* Moire is a type of natural interference which produces soft, wavy lines on your screen. It may appear due to interference between the pattern of the picture on the screen and the phosphor pitch pattern of the monitor.

Example of moire:



Press the  button once to return to the MENU OSD, and twice to return to normal viewing. If no buttons are pressed, the OSD closes automatically after about 30 seconds.





To reset, press the  (reset) button while the OSD is on.

## Changing the on-screen display position





You can change the OSD position (for example, when you want to adjust the picture behind the OSD).

- 1 Press the  button.  
The MENU OSD appears.

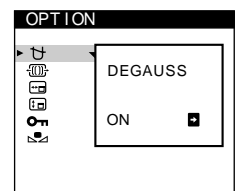
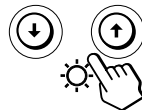

- 2 Press the / buttons to select " OPTION" and press the  button again.  
The OPTION OSD appears.



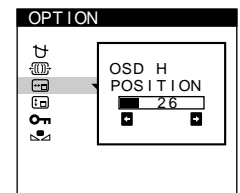
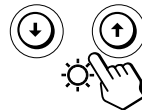

- 3 Press the / buttons to select " (OSD H POSITION)" or " (OSD V POSITION)." Select " (OSD H POSITION)" to adjust the horizontal position.



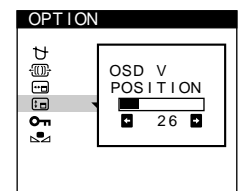
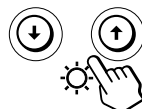

Select " (OSD V POSITION)" to adjust the vertical position.

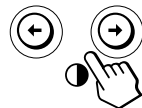

- 4 Press the / buttons to move the OSD to the desired position.



Press the  button once to return to the MENU OSD, and twice to return to normal viewing. If no buttons are pressed, the OSD closes automatically after about 30 seconds.





To reset, press the  (reset) button while the OSD is on.

## Locking the controls



You can protect adjustment data by locking the controls.

- 1 Press the  button.  
The MENU OSD appears.

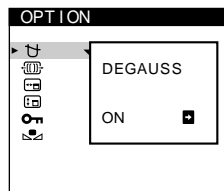
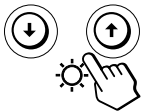

- 2 Press the / buttons to select " OPTION" and press the  button again.  
The OPTION OSD appears.





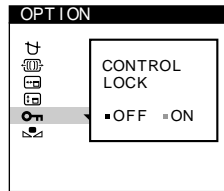
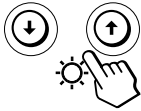

- 3 Press the / buttons to select " (CONTROL LOCK)."

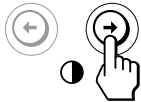

- 4 Press the  button to select "ON."



Press the  button once to return to the MENU OSD, and twice to return to normal viewing. If no buttons are pressed, the OSD closes automatically after about 30 seconds.

Only the  (power) switch, EXIT, and " (CONTROL LOCK)" of the " OPTION" OSD will operate. If any other items are selected, the  mark appears on the screen.

### To cancel the control lock





Repeat steps 1 through 3 above and press the  button to select "OFF."

## Restoring the color



The colors of most display monitors tend to gradually lose brilliance over several years of service. The IMAGE RESTORATION feature allows you to restore the color to the original factory quality levels.

- 1 Press the  button.  
The MENU OSD appears.

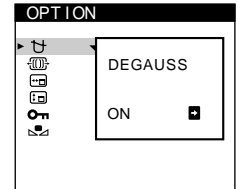
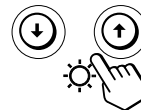

- 2 Press the / buttons to select " OPTION" and press the  button again.  
The OPTION OSD appears.



- 3 Press the / buttons to select " (IMAGE RESTORATION)."

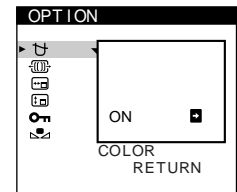
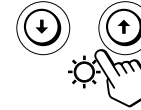

- 4 Press the  button to select "ON."



The picture disappears while the color is being restored (about 2 seconds). After the color is restored, the picture reappears on the screen again.

Press the  button once to return to the MENU OSD, and twice to return to normal viewing. If no buttons are pressed, the OSD closes automatically after about 30 seconds.

## Notes

- Before using this feature, the monitor must be in normal operation mode (green power indicator on) for at least 30 minutes. If the monitor goes into power saving mode, you must return the monitor to normal operation mode and wait for 30 minutes for the monitor to be ready. You may need to adjust your computer's power saving settings to keep the monitor in normal operation mode for the full 30 minutes. If the monitor is not ready, the following message will appear.

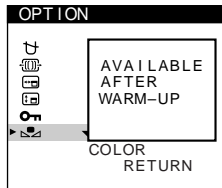





- The monitor may gradually lose its ability to perform this function due to the natural aging of the picture tube.

## Using the HELP On-screen Display



The HELP OSD contains helpful hints and information about this monitor. If your monitor is displaying symptoms that match those listed in the HELP OSD, follow the on-screen instructions to resolve the problem. If the symptoms do not match those listed in the HELP OSD or if the problem persists, see “Troubleshooting” on page 18.

- 1 Press the  button.  
The MENU OSD appears.

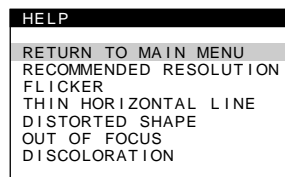
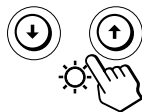

- 2 Press the / buttons to select “ HELP” and press the  button again.  
The HELP OSD appears.



- 3 Press the / buttons to select a HELP menu item.  
Instructions or information to resolve the problem appears on the screen. An explanation of each menu item is given below.

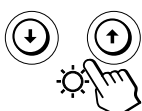

## RECOMMENDED RESOLUTION

If the picture does not fill the screen to the edges or if the picture appears too large for the screen, adjust the resolution to the figures shown in the OSD using your computer. If the input signal matches one of this monitor's factory preset modes, the resolution and refresh rate of the current input signal are displayed.

## FLICKER

If the picture is flickering, adjust the refresh rate to figures shown in the OSD. If the input signal matches one of this monitor's factory preset modes, the refresh rate of the current input signal is displayed.

## THIN HORIZONTAL LINE

The lines that appear on your screen are damper wires. See page 16 for more information about the damper wires.



## DISTORTED SHAPE

If the shape of the picture on the screen seems distorted, try adjusting the picture's geometry. Press the  button to jump directly to the GEOMETRY OSD.

## OUT OF FOCUS

The picture may seem to be out of focus when the red and blue color signals are not aligned properly, causing red or blue shadows to appear around letters and lines. Try adjusting the picture's convergence to make the shadows disappear. Press the  button to jump directly to the CONVERGENCE OSD. When the CONVERGENCE OSD is displayed, the contrast, brightness, and moire adjustment settings are automatically reset for all input signals.



## DISCOLORATION

If the picture's color appears abnormal in certain areas of the screen, first check for any loose signal cables. After you have checked the cables, try degaussing (demagnetizing) the screen manually. Press the  button to jump directly to the OPTION OSD, then select  (DEGAUSS).

Press the  button once to return to the MENU OSD, and twice to return to normal viewing. If no buttons are pressed, the OSD closes automatically after about 30 seconds.

## Resetting the Adjustments

### Resetting an adjustment item

- 1 Press the  and  buttons to select the OSD containing the item you want to reset, and press the  button again.



- 2 Press the  buttons to select the item you want to reset.

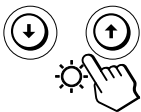

- 3 Press the  (reset) button.

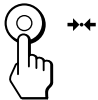

### Resetting all of the adjustment data for the current input signal

When there is no OSD displayed, press the  (reset) button.

All of the adjustment data for the current input signal is reset to the factory settings.

Note that resetting the current signal does not affect brightness and contrast, OSD language, OSD position or control lock.

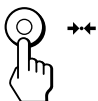



### Resetting all of the adjustment data for all input signals

Press and hold the  (reset) button for more than two seconds.

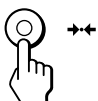
All of the adjustment data, including the brightness and contrast, is reset to the factory settings.



#### Note

The  (reset) button does not function when  (CONTROL LOCK) is set to ON.

## Power Saving Function

This monitor meets the power-saving guidelines set by VESA and ENERGY STAR, as well as the more stringent NUTEK.

If the monitor is connected to a computer or video graphics board that is VESA DPMS (Display Power Management Signaling) compliant, the monitor will automatically reduce power consumption in three stages as shown below.

	Power consumption mode	Screen	Horizontal sync signal	Vertical sync signal	Power consumption	Recovery time	⏻ indicator
1	Normal operation	active	present	present	≤ 140 W	—	Green
2	Standby (1st mode)	blank	absent	present	≤ 15 W	Approx. 5 sec.	Green and orange alternate
3	Suspend (2nd mode) (sleep)*	blank	present	absent	≤ 15 W	Approx. 5 sec.	Green and orange alternate
4	Active-off (3rd mode) (deep sleep)*	blank	absent	absent	≤ 3 W	Approx. 15 sec.	Orange
5	Power-off	—	—	—	≤ 0.5 W	—	Off

\* "Sleep" and "deep sleep" are power saving modes defined by the Environmental Protection Agency.

### Notes

- When your computer is in a power saving mode, MONITOR IS IN POWER SAVE MODE appears on the screen if you press any button on the monitor (page 17). After a few seconds, the monitor enters the power saving mode again. Once the horizontal and vertical sync signals are detected, the monitor automatically resumes its normal operation mode.
- The power management feature is invoked when the computer recognizes that you have not used your mouse or keyboard for a user-definable period of time.
- IBM recommends that you switch off your monitor at the end of each working day, or whenever you expect to leave it unused for long periods during the day.

## Damper Wires

When viewing a white background, very thin horizontal lines may be visible on the screen as shown below. These lines are the shadows of the damper wires and are characteristic of CRTs that use aperture grilles. The wires are attached to the aperture grille on the inside of the Trinitron tube and prevent the vibration of the aperture grille.

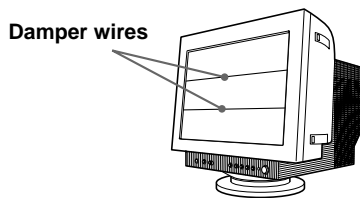

## Plug & Play

This monitor complies with the DDC1, DDC2B and DDC2Bi Display Data Channel (DDC) standards of VESA. When a DDC1 host system is connected, the monitor synchronizes with the V. CLK in accordance with the VESA standards and outputs the EDID (Extended Display Identification Data) to the data line. When a DDC2B or DDC2Bi host system is connected, the monitor automatically switches to the appropriate standard.



### Preset Modes

No.	Resolution (dots × lines)	Horizontal Frequency	Vertical Frequency	Graphics Mode
1	640 × 480	31.5 kHz	60 Hz	VGA
2	640 × 480	43.3 kHz	85 Hz	VESA
3	800 × 600	46.9 kHz	75 Hz	VESA
4	800 × 600	53.7 kHz	85 Hz	VESA
5	1024 × 768	60.0 kHz	75 Hz	VESA
6	1024 × 768	68.7 kHz	85 Hz	VESA
7	1280 × 1024	80.0 kHz	75 Hz	VESA
8	1280 × 1024	91.1 kHz	85 Hz	VESA
9	1600 × 1200	93.8 kHz	75 Hz	VESA
10	1600 × 1200	106.3 kHz	85 Hz	VESA

### Displaying the Monitor's Information

You can display the model name, serial number and year of manufacture using the monitor's INFORMATION OSD.

Press and hold the  button for 3 seconds.  
The INFORMATION OSD appears.

Example:

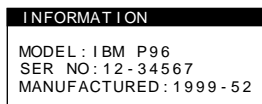

The INFORMATION OSD includes the model name, serial number, and manufactured year.

The OSD automatically disappears after about 30 seconds.

### Warning Messages



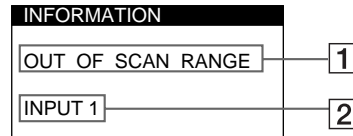



If no pictures appears on the screen, one of the following messages appears on the screen. To solve the problem, see "Troubleshooting" on page 18.



- 1 The input signal condition**  
**OUT OF SCAN RANGE**  
 indicates that the input signal is not supported by the monitor's specifications.  
**NO INPUT SIGNAL**  
 indicates that no signal is input.  
**MONITOR IS IN POWER SAVE MODE**  
 indicates that the computer is in power saving mode. This message is displayed only when your computer is in a power saving mode and you press any one of the buttons on the monitor.
- 2 The selected connector**  
 This message shows the currently selected connector (INPUT 1 or INPUT 2).

## Troubleshooting

This section may help you isolate the cause of a problem and as a result, eliminate the need to contact technical support.

Symptom	Check these items
<b>No picture</b>	
If the  indicator is not lit	<ul style="list-style-type: none"> <li>• Check that the power cord is properly connected.</li> <li>• Check that the  (power) switch is in the “on” position.</li> </ul>
If the “NO INPUT SIGNAL” message appears on the screen, or if the  indicator is either orange or alternating between green and orange	<ul style="list-style-type: none"> <li>• Check that your computer power switch is in the “on” position.</li> <li>• Check that the Input 1-2 switch setting is correct (page 5).</li> <li>• Check that the video signal cable is properly connected and all plugs are firmly seated in their sockets.</li> <li>• Ensure that no pins are bent or pushed in the video input connector.</li> <li>• Check that the graphic board is completely seated in the proper bus slot.</li> </ul>
If the “MONITOR IS IN POWER SAVE MODE” message appears on the screen, or if the  indicator is either orange or alternating between green and orange	<ul style="list-style-type: none"> <li>• The computer is in power saving mode. Try pressing any key on the computer keyboard, or moving the mouse.</li> <li>• Check that your computer power switch is in the “on” position.</li> <li>• Check that the graphic board is completely seated in the proper bus slot.</li> </ul>
If the “OUT OF SCAN RANGE” message appears on the screen	<ul style="list-style-type: none"> <li>• Check that the video frequency range is within that specified for the monitor. (Horizontal: 30 – 107kHz, Vertical: 48 – 120 Hz) Refer to your computer’s instruction manual to adjust the video frequency range.</li> <li>• If you are using a video signal cable adapter, check that it is the correct one.</li> </ul>
If no message is displayed and the  indicator is green or flashing orange	<ul style="list-style-type: none"> <li>• See “Self-diagnosis Function” (page 20).</li> </ul>
<b>Picture is scrambled</b>	<ul style="list-style-type: none"> <li>• Check your graphics board manual for the proper monitor setting.</li> <li>• Check this manual and confirm that the graphics mode and the frequency you are trying to operate at is supported. Even if the frequency is within the proper range, some graphic boards may have a sync pulse that is too narrow for the monitor to sync correctly.</li> </ul>
<b>Color is not uniform</b>	<ul style="list-style-type: none"> <li>• Degauss the monitor (page 11). If you place equipment which generates a magnetic field, such as a loudspeaker, near the monitor, or you change the direction of the monitor, color may lose uniformity. The degauss function demagnetizes the metal frame of the CRT to obtain a neutral field for uniform color reproduction. If a second degauss cycle is needed, allow a minimum interval of 20 minutes for the best result.</li> </ul>
<b>You cannot adjust the monitor with the buttons on the front panel</b> (  appears on the screen)	<ul style="list-style-type: none"> <li>• If the control lock function is set to ON, set it to OFF using the OPTION OSD (page 13).</li> </ul>
<b>White does not look white</b>	<ul style="list-style-type: none"> <li>• Adjust the color temperature (page 9).</li> </ul>

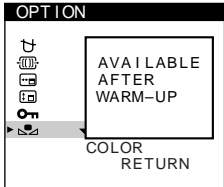
Symptom	Check these items
Screen image is not centered or sized properly	<ul style="list-style-type: none"> <li>• Press  button (page 5).</li> <li>• Adjust the size or centering (page 7). Some video modes do not fill the screen to the edges. This problem tends to occur with certain graphic boards.</li> </ul>
Edges of the image are curved	<ul style="list-style-type: none"> <li>• Adjust the geometry (page 8).</li> </ul>
White lines show red or blue shadows at edges	<ul style="list-style-type: none"> <li>• Adjust the convergence (page 10).</li> </ul>
Picture is fuzzy	<ul style="list-style-type: none"> <li>• Adjust the contrast and brightness (page 6).</li> <li>• Degauss the monitor (page 11). If you place equipment which generates a magnetic field, such as a loudspeaker, near the monitor, or you change the direction of the monitor, color may lose uniformity. The degauss function demagnetizes the metal frame of the CRT to obtain a neutral field for uniform color reproduction. If a second degauss cycle is needed, allow a minimum interval of 20 minutes for the best result.</li> <li>• If red or blue shadows appear along the edges of images, adjust the convergence (page 10).</li> <li>• Select MOIRE ADJUST and adjust the moire cancellation effect (page 12).</li> </ul>
Picture bounces or has wavy oscillations	<ul style="list-style-type: none"> <li>• Isolate and eliminate any potential sources of electric or magnetic fields. Common causes for this symptom are electric fans, fluorescent lighting, or laser printers.</li> <li>• If you have another monitor close to this monitor, increase the distance between them to reduce the interference.</li> <li>• Try plugging the monitor into a different AC outlet, preferably on a different circuit.</li> <li>• Try the monitor on a different computer in a different room.</li> </ul>
Picture is flickering	<ul style="list-style-type: none"> <li>• Set the refresh rate on the computer to obtain the best possible picture by referring to your computer's manual.</li> </ul>
Picture appears to be ghosting	<ul style="list-style-type: none"> <li>• Eliminate the use of video cable extensions and/or video switch boxes if this symptom occurs. Excessive cable length or a weak connection can produce this symptom.</li> </ul>
Wavy or elliptical (moire) pattern is visible	<ul style="list-style-type: none"> <li>• Select MOIRE ADJUST and adjust the moire cancellation effect (page 12). The moire may be modified depending on the connected computer.</li> <li>• Change your desktop pattern. Due to the relationship between resolution, monitor dot pitch and the pitch of some image patterns, certain screen backgrounds sometimes show moire.</li> </ul>
Two fine horizontal lines (wires) are visible	<ul style="list-style-type: none"> <li>• These wires stabilize the vertically striped aperture grille (page 16). This aperture grille allows more light to pass through to the screen giving the Trinitron CRT more color and brightness.</li> </ul>
<b>IMAGE RESTORATION function does not operate</b> 	<ul style="list-style-type: none"> <li>• Before using this function, the monitor must be in normal operation mode (green power indicator on) for at least 30 minutes. For more information on using the IMAGE RESTORATION function, see "Restoring the color" on page 13.</li> <li>• Adjust the computer's power saving settings to keep the monitor in normal operation mode for more than 30 minutes.</li> <li>• The monitor may gradually lose its ability to perform this function due to the natural aging of the picture tube.</li> </ul>
Hum is heard right after the power is turned on	<ul style="list-style-type: none"> <li>• When the power is turned on, the auto-degauss cycle is activated. While the auto-degauss cycle is activated, a hum may be heard. The same hum is heard when the monitor is manually degaussed. This is not a malfunction.</li> </ul>



- If the problem persists, call the IBM HelpCenter.  
In the US. call 1-800-772-2227  
In Canada call 1-800-565-3344
- Note the model name and the serial number of your monitor. Also note the make and name of your computer and graphic board.

### Self-diagnosis Function

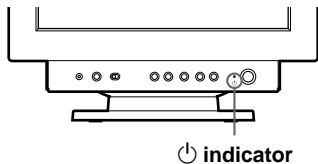
This monitor is equipped with a self-diagnosis function. If there is a problem with your monitor or computer, the screen will go blank and the  indicator will either light up green or flash orange.



#### If the indicator is green

- 1 Disconnect the video input cable or turn off the connected computer.
- 2 Press the  button twice to turn the monitor off and then on.
- 3 Press and hold the  button for 2 seconds before the monitor enters power saving mode.

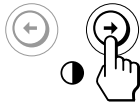



If all four color bars appear (white, red, green, blue), the monitor is working properly. Reconnect the video input cable and check the condition of your computer.

If the color bars do not appear, there is a potential monitor failure. Inform the IBM HelpCenter of the monitor's condition.

#### If the indicator is flashing orange

Press the  button twice to turn the monitor off and then on.

If the  indicator lights up green, the monitor is working properly.

If the  indicator is still flashing, there is a potential monitor failure. Inform the IBM HelpCenter of the monitor's condition. Be sure to note the model name and serial number of your monitor. Also note the make and model of your computer and video board.

### Specifications

Picture tube	0.24 mm aperture grille pitch 19 inches measured diagonally 90-degree deflection
Viewable image size	Approx. 365 × 274 mm (w/h) (14 <sup>3</sup> / <sub>8</sub> × 10 <sup>7</sup> / <sub>8</sub> inches) 18.0" viewable diagonal
Resolution	Horizontal: Max. 1600 dots Vertical: Max. 1200 lines
Standard image area	Approx. 352 × 264 mm (w/h) (13 <sup>7</sup> / <sub>8</sub> × 10 <sup>1</sup> / <sub>2</sub> inches)
Deflection frequency*	Horizontal: 30 to 107kHz Vertical: 48 to 120 Hz 256 < Total Line < 2048
AC input voltage/current	100 to 240 V, 50 – 60 Hz, Max. 2.0 A
Power consumption	Max. 140 W
Operating temperature	10°C to 40°C
Dimensions	Approx. 462 × 462 × 474 mm (w/h/d) (18 <sup>1</sup> / <sub>4</sub> × 18 <sup>1</sup> / <sub>4</sub> × 18 <sup>3</sup> / <sub>4</sub> inches)
Mass	Approx. 27 kg (59 lb 8 oz)

- \* Recommended horizontal and vertical timing condition
- Horizontal sync width should be more than 1.0 μsec.
  - Horizontal blanking width should be more than 3.0 μsec.
  - Vertical blanking width should be more than 450 μsec.

Design and specifications are subject to change without notice.

# Français

# Edition 1

Cette documentation peut contenir des inexactitudes techniques ou des erreurs typographiques. Des modifications y sont régulièrement apportées et intégrées à des éditions ultérieures. IBM peut apporter, à tout moment, des améliorations et/ou des modifications au(x) produit(s) ou programme(s) décrits dans cette documentation.

Cette documentation peut contenir des références ou des informations sur des produits (machines ou programmes), des programmes ou des services IBM non annoncés dans votre pays.

Toute demande d'informations techniques concernant des produits IBM doit être formulée auprès de votre fournisseur agréé IBM ou de votre représentant commercial IBM.

Cette documentation ne peut pas être reproduite ou distribuée sous quelque forme que ce soit sans l'autorisation écrite préalable de International Business Machines Corporation.

Toute référence faite dans cette documentation à des produits, programmes ou services IBM ne constituent pas un engagement de la part d'IBM de fournir ces produits, programmes et services dans tous les pays dans lesquels la société IBM est présente. Par ailleurs, toute référence à un produit, programme ou service. Par ailleurs, toute référence à un produit, programme ou service IBM ne signifie pas et n'implique pas que seul un produit, programme ou service IBM peut être utilisé. Tout produit, programme ou service équivalent qui n'enfreint pas les droits de propriété intellectuelle d'IBM ou tout autre droit relevant d'une protection juridique peut être utilisé au lieu du produit, programme ou service IBM. L'évaluation et le contrôle du fonctionnement du produit en association avec d'autres produits, programmes ou services, à l'exception de ceux expressément désignés par IBM relèvent de la responsabilité de l'utilisateur.

IBM peut disposer de brevets ou de demandes de brevets en attente couvrant les sujets énoncés dans ce document. Toutefois, ce document ne constitue en aucun cas une licence d'utilisation de ces brevets.

## Marques déposées

Les termes suivants, utilisés dans cette documentation, sont des marques commerciales ou des marques de service de IBM Corporation aux Etats-Unis et dans d'autres pays:

### **IBM VGA HelpCenter**

- ENERGY STAR est une marque déposée aux Etats-Unis.
- Trinitron® est une marque commerciale déposée de Sony Corporation.
- DDC™ est une marque déposée de Video Electronics Standard Association.
- VESA est une marque de commerce de Video Electronics Standard Association.
- Tous les autres noms de produits mentionnés dans ce mode d'emploi sont des marques de commerce ou des marques déposées de leurs détenteurs respectifs.
- Par ailleurs, "™" et "®" ne sont pas repris à chaque fois dans le mode d'emploi.

© Copyright International Business Machines Corporation 1999.

Tous droits réservés.

# TABLE DES MATIERES







---

## Préparation

Précautions .....	2
Identification des composants et des commandes .....	3
Installation .....	4
Sélection du signal d'entrée .....	5
Réglage automatique de la taille et du centrage de l'image .....	5

---

## Personnalisation de l'affichage

Sélection de la langue d'affichage des menus .....	6
Réglage de la luminosité et du contraste de l'image .....	6
Présentation du système d'écrans de menu .....	6
Utilisation de l'écran de menu TAILLE/CENTRE  .....	7
Utilisation de l'écran de menu GEOMETRIE  .....	8
Utilisation de l'écran de menu COULEUR  .....	9
Utilisation de l'écran de menu CONVERGENCE  .....	10
Utilisation de l'écran de menu LANGUAGE  .....	11
Utilisation de l'écran de menu OPTION  .....	11
Utilisation de l'écran de menu AIDE  .....	14
Réinitialisation des réglages .....	15

---

## Caractéristiques techniques

Fonction d'économie d'énergie .....	16
Fils d'amortissement .....	16
Un moniteur prêt à l'emploi ("Plug & Play") .....	16
Modes présélectionnés .....	17
Affichage des informations sur le moniteur .....	17

---

## Informations complémentaires

Messages d'avertissement .....	17
Guide de dépannage .....	18
Fonction d'autodiagnostic .....	20
Spécifications .....	20

## Précautions

### Installation

- Veillez à assurer une circulation d'air adéquate pour éviter une surchauffe interne de l'appareil. Ne placez pas le moniteur sur des surfaces textiles (tapis, couvertures, etc.) ni à proximité de rideaux ou de draperies susceptibles d'obstruer les orifices de ventilation.
- N'installez pas le moniteur à proximité de sources de chaleur comme un radiateur ou une bouche d'air chaud, ni dans un endroit exposé au rayonnement solaire direct, à des poussières en excès, à des vibrations ou à des chocs mécaniques.
- N'installez pas le moniteur à proximité d'équipements qui génèrent un champ magnétique tels qu'un convertisseur ou des lignes à haute tension.

### Entretien

- Nettoyez le châssis, le panneau et les commandes à l'aide d'un chiffon doux légèrement imprégné d'une solution détergente neutre. N'utilisez jamais de tampons abrasifs, de poudre à récurer ou de solvants tels que de l'alcool ou du benzène.
- Ne frottez pas, ne touchez pas et ne tapotez pas la surface de l'écran avec des objets abrasifs ou aux arêtes vives comme un stylo à bille ou un tournevis. Ce type de contact risque en effet de rayer le tube image.
- Nettoyez l'écran à l'aide d'un chiffon doux. Si vous utilisez un produit nettoyant pour vitres, n'utilisez aucun type de produit contenant une solution antistatique ou des additifs similaires parce que vous risquez de rayer le revêtement de l'écran.

### Transport

Pour transporter ce moniteur en vue de réparations ou de son expédition, utilisez le carton d'emballage et les matériaux de conditionnement d'origine.

## Utilisation du support pivotant

Ce moniteur peut être réglé suivant les angles précisés ci-dessous. Pour localiser le centre du rayon de pivotement du moniteur, alignez le centre de l'écran du moniteur sur les points de centrage du support.

Pour faire pivoter le moniteur horizontalement ou verticalement, saisissez-le des deux mains par la base. Veillez à ne pas vous coincer les doigts à l'arrière du moniteur lorsque vous le faites pivoter verticalement.

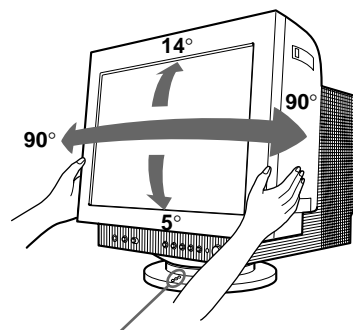

Points de centrage

### Remarque

Ne retirez pas la base pivotante et inclinable du moniteur.

## Avertissement sur le raccordement à la source d'alimentation

- Utilisez un cordon d'alimentation convenant à votre alimentation secteur locale.

### Modèles de fiches :

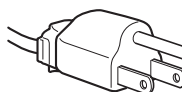

pour 100 à 120 V CA

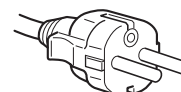

pour 200 à 240 V CA

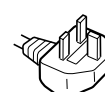

pour 240 V CA  
uniquement

- Avant de débrancher le cordon d'alimentation, attendez au moins 30 secondes après avoir actionné le commutateur d'alimentation de manière à permettre la décharge de l'électricité statique à la surface de l'écran à tube cathodique (CRT).
- Après que le courant a été branché, le CRT est démagnétisé pendant environ 5 secondes. Cela génère un puissant champ magnétique autour de l'encadrement métallique qui peut affecter les données mémorisées sur une bande magnétique ou des disquettes situées à proximité. Placez ces systèmes d'enregistrement magnétique et ces bandes/disquettes à l'écart de ce moniteur.

Veillez installer l'appareil à proximité d'une prise de courant facile d'accès.



## Identification des composants et des commandes

Pour plus de détails, reportez-vous aux pages indiquées entre parenthèses.

### Partie frontale

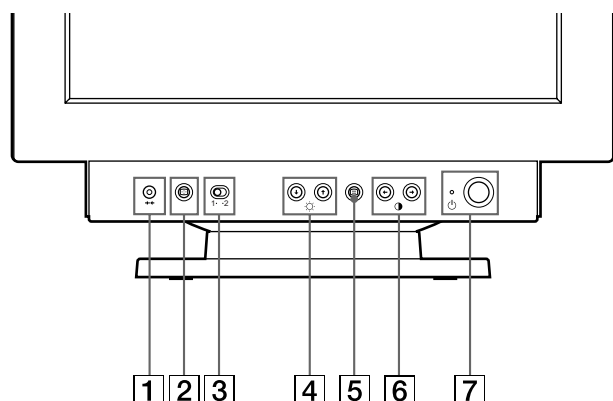

- 1 Touche →← (réinitialisation) (page 15)**  
Réinitialise les réglages aux valeurs par défaut.
- 2 Touche ⊕ (taille et centrage automatiques) (page 5)**  
Cette touche ajuste automatiquement la taille et le centrage de l'image.
- 3 Commutateur INPUT 1-2 (entrée) (page 5)**  
Ce commutateur sélectionne INPUT 1 (connecteur d'entrée vidéo 1) ou INPUT 2 (connecteur d'entrée vidéo 2).
- 4 Touches ☀ (luminosité) vers le haut et vers le bas (↓/↑) (pages 6-15)**  
Règlent la luminosité de l'image.  
Servent de touches (↓/↑) pour le réglage d'autres paramètres.
- 5 Touche ≡ (menu) (pages 6-15, 17)**  
Affiche l'écran MENU.
- 6 Touches ● (contraste) vers la gauche et vers la droite (←/→) (pages 6-15, 20)**  
Règlent le contraste de l'image.  
Servent de touches (←/→) pour le réglage d'autres paramètres.
- 7 Commutateur et indicateur d'alimentation ⏻ (pages 16, 20)**  
Met le moniteur sous et hors tension.  
L'indicateur d'alimentation s'allume en vert lorsque le moniteur est sous tension et clignote en vert et en orange ou s'allume en orange lorsque le moniteur se trouve en mode d'économie d'énergie.

### Partie arrière

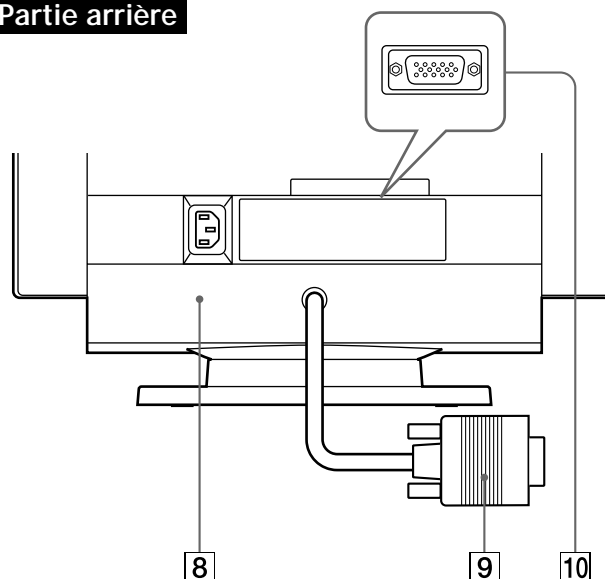

- 8 Connecteur AC IN (page 4)**  
Assure l'alimentation du moniteur.
- 9 Connecteur d'entrée vidéo 1 (HD15) (page 4)**  
Entre les signaux vidéo RVB (0,700 Vcc, positifs) et les signaux SYNC.

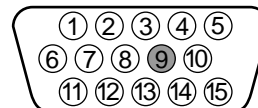

Broche n°	Signal	Broche n°	Signal
1	Rouge	9	—
2	Vert (Synchronisation sur le vert)	10	Masse
		11	ID (Masse)
		12	Données bidirectionnelles (SDA)*
3	Bleu	13	Sync H
4	ID (Masse)		Sync V
5	Masse DDC*	15	Données d'horloge (SCL)*
6	Masse rouge		
7	Masse vert		
8	Masse bleu		

\* Norme Display Data Channel (DDC) de VESA

- 10 Connecteur d'entrée vidéo 2 (HD15) (page 4)**  
Entre les signaux vidéo RVB (0,700 Vcc, positifs) et les signaux SYNC.  
Voir tableau ci-dessus pour l'assignation des broches.

## Installation

Ce moniteur fonctionne avec des plates-formes tournant à des fréquences horizontales comprises entre 30 et 107 kHz.

### 1re étape: Assurez-vous que l'ordinateur et le moniteur sont éteints

### 2e étape: Raccordez le moniteur à l'ordinateur

Raccordez le câble de signal vidéo à la sortie vidéo de l'ordinateur.

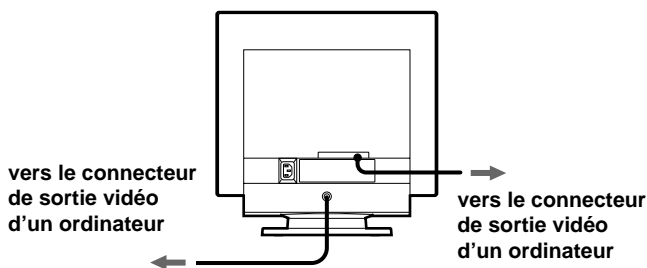

#### Remarque

Ne court-circuitez pas les broches du câble de signal vidéo.

### 3e étape: Branchez le cordon d'alimentation

Le moniteur étant hors tension, branchez le cordon d'alimentation à la tension locale voulue au moniteur et l'autre extrémité à une prise murale.

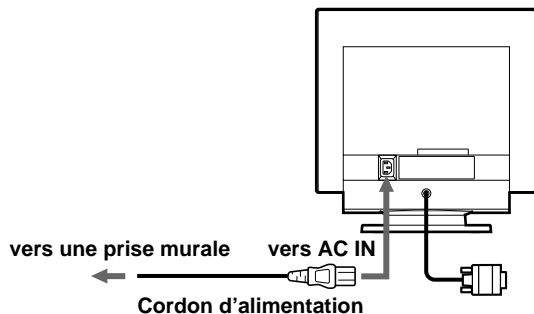

### 4e étape: Mettez le moniteur et l'ordinateur sous tension

### 5e étape: Ajustez les commandes du moniteur en fonction de vos préférences personnelles

L'installation de votre moniteur est à présent terminée.

#### Remarque

Si aucune image n'apparaît à l'écran et que l'indication "HORS PLAGES DE BALAYAGE" ou "MONITEUR EN MODE D'ECONOMIE D'ENERGIE" apparaît à l'écran, reportez-vous à "Messages d'avertissement" à la page 17.

### Préparation du lieu de travail

#### Positionnement du moniteur

Choisissez un endroit approprié pour installer le moniteur, à l'écart d'une lampe de bureau fluorescente et de tout autre appareil générant des champs magnétiques susceptibles de provoquer des interférences. Assurez-vous que le meuble ou l'équipement peut supporter le poids du moniteur. Laissez au moins 50 mm (2 pouces) d'espace de ventilation autour du moniteur.

#### Hauteur

Le moniteur doit être positionné de telle façon que le haut de l'écran se situe juste sous le niveau de vos yeux lorsque vous êtes assis à votre poste de travail.

#### Orientation

Choisissez un emplacement où vous avez le moins de réflexions possible de luminaires et de fenêtres, soit perpendiculairement aux fenêtres. Le moniteur doit être positionné directement face à vous de façon à ce que vous ne deviez pas pivoter sur vous-même. Inclinez le moniteur jusqu'à obtention d'un angle de visualisation confortable.

### Habitudes de travail

#### Repos

Prenez des pauses à intervalles réguliers. Variez d'attitude et levez-vous occasionnellement pour vous étirer parce que l'utilisation prolongée d'un poste de travail informatique peut s'avérer fatigante.

#### Dos

Asseyez-vous sur un siège et placez le dos contre le dossier.

#### Mains

Appliquez de légères pressions sur le clavier en gardant les mains et les doigts décontractés. Laissez un espace devant le clavier pour reposer les poignets lorsque vous ne tapez pas. Envisagez l'utilisation d'un repose-poignets.

#### Acuité visuelle

Le travail à l'écran, comme tout autre type de travail à courte distance, peut causer une fatigue oculaire. Regardez périodiquement au-delà de votre écran et faites contrôler régulièrement votre acuité visuelle.

#### Réglages de l'écran

Régalez les niveaux de luminosité et de contraste à un niveau confortable. Il se peut que vous deviez modifier ces réglages suivant les changements de la lumière au fil de la journée. De nombreux programmes d'application vous permettent de sélectionner des combinaisons de couleurs pour accroître votre confort d'utilisation.

## Sélection du signal d'entrée

Vous pouvez raccorder deux ordinateurs à ce moniteur à l'aide des connecteurs d'entrée vidéo 1 et vidéo 2. Pour sélectionner l'un des deux ordinateurs, utilisez le commutateur INPUT 1-2.

Réglez le commutateur INPUT 1-2.

Le connecteur sélectionné apparaît à l'écran pendant 3 secondes.



“ENTREE 1” (connecteur d'entrée vidéo 1) ou “ENTREE 2” (connecteur d'entrée vidéo 2) apparaît à l'écran.

### Remarque

Si aucun signal n'est entré via le connecteur sélectionné, l'indication PAS ENTREE VIDEO apparaît à l'écran. Au bout de quelques secondes, le moniteur passe en mode d'économie d'énergie. Si cela se produit, commutez l'autre connecteur.

## Réglage automatique de la taille et du centrage de l'image

Vous pouvez aisément ajuster l'image pour qu'elle remplisse l'écran jusqu'aux bords en appuyant sur la touche  (taille et centrage automatiques).

Appuyez sur la touche .

L'image remplit automatiquement l'écran.

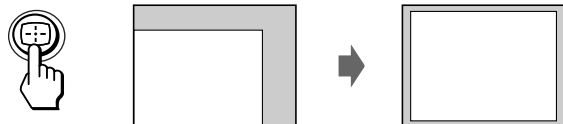

### Remarques

- Cette fonction est destinée à être utilisée avec un ordinateur capable d'afficher une image plein écran. Il se peut qu'elle ne fonctionne pas correctement si la couleur d'arrière-plan est foncée ou si l'image entrée ne remplit pas l'écran jusqu'aux bords.
- Les images d'un rapport hauteur/largeur de 5:4 (résolution: 1280 × 1024) sont affichées suivant leur résolution réelle et ne remplissent pas l'écran jusqu'aux bords.
- L'image affichée se déplace pendant quelques secondes lorsque vous appuyez sur la touche . Il ne s'agit pas d'un dysfonctionnement.

Avant le réglage

- Raccordez le moniteur et l'ordinateur et mettez-les sous tension.



## Sélection de la langue d'affichage des menus

Pour changer la langue d'affichage des écrans de menu, voir la section "Utilisation de l'écran de menu LANGUAGE  à la page 11.

Le réglage par défaut est l'anglais.

## Réglage de la luminosité et du contraste de l'image

Une fois le réglage effectué, il sera conservé en mémoire pour tous les signaux d'entrée reçus.

- 1 Appuyez sur les touches  (luminosité)  $\downarrow/\uparrow$  ou  (contraste)  $\leftarrow/\rightarrow$ .  
L'écran de menu LUMINOSITE/CONTRASTE apparaît.

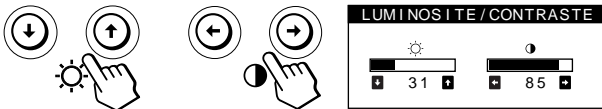

- 2 Pour le réglage de la luminosité Appuyez sur les touches  $\downarrow/\uparrow$ .

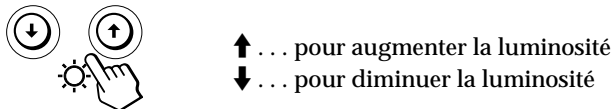

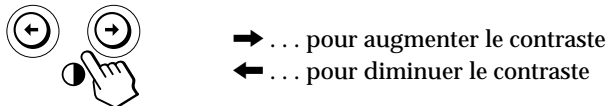

Pour le réglage du contraste Appuyez sur les touches  $\leftarrow/\rightarrow$ .



L'écran de menu disparaît automatiquement au bout d'environ 3 secondes.

Pour ramener le réglage à sa valeur par défaut, appuyez sur la touche  $\rightarrow\leftarrow$  (réinitialisation) alors que l'écran de menu est affiché. La luminosité et le contraste sont simultanément ramenés à la valeur de réglage par défaut.

Si vous réglez sRGB sur "ON" pour le réglage de la couleur, la luminosité () et le contraste () se règlent automatiquement sur "31" et "85".

Pour plus d'informations concernant sRGB, voir "Utilisation de l'écran de menu COULEUR  à la page 9.

## Présentation du système d'écrans de menu

La plupart des réglages sont effectués à l'aide de l'écran MENU.

### Ecran MENU

Appuyez sur la touche  pour afficher l'écran MENU. Cet écran MENU contient des liens avec les autres écrans de menu décrits ci-dessous.

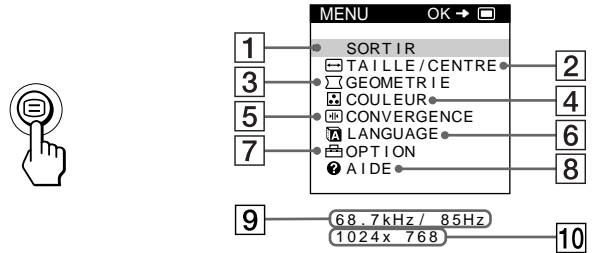

- 1 **SORTIR**  
Referme l'écran MENU.
- 2 **TAILLE/CENTRE**  
Affiche l'écran de menu TAILLE/CENTRE afin d'ajuster la taille de l'image, le centrage ou le zoom.
- 3 **GEOMETRIE**  
Affiche l'écran de menu GEOMETRIE pour régler la rotation et la distorsion en coussin de l'image, etc.
- 4 **COULEUR**  
Affiche l'écran de menu COULEUR pour le réglage de la température des couleurs.
- 5 **CONVERGENCE**  
Affiche l'écran de menu CONVERGENCE afin d'ajuster la convergence horizontale et verticale de l'image.
- 6 **LANGUAGE**  
Affiche l'écran de menu LANGUAGE pour sélectionner la langue d'affichage.
- 7 **OPTION**  
Affiche l'écran de menu OPTION pour ajuster la position de l'écran de menu et démagnétiser l'écran, etc.
- 8 **AIDE**  
Affiche l'écran de menu AIDE afin d'obtenir des conseils et des informations relatives à ce moniteur.
- 9 **Fréquences horizontale et verticale du signal d'entrée en cours**  
Les fréquences horizontale et verticale du signal d'entrée en cours sont affichées.
- 10 **Résolution du signal d'entrée en cours**  
Si le signal correspond à l'un des modes présélectionnés en usine pour le moniteur, la résolution s'affiche.

## Utilisation de l'écran de menu TAILLE/CENTRE

Les réglages TAILLE/CENTRE vous permettent de régler la taille de l'image, le centrage ou le zoom.  
Une fois que le réglage est effectué, il sera conservé en mémoire pour le signal d'entrée en cours.

- 1 Appuyez sur la touche .  
L'écran MENU apparaît.





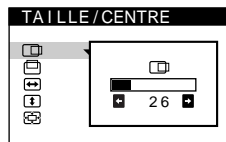
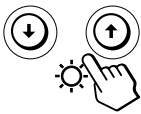

- 2 Appuyez sur les touches ↓/↑ pour sélectionner "TAILLE/CENTRE" et appuyez de nouveau sur la touche .  
L'écran de menu TAILLE/CENTRE apparaît.

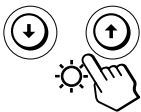







- 3 Appuyez sur les touches ↓/↑ pour sélectionner le paramètre que vous voulez régler.

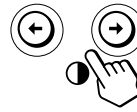



Sélectionnez	Pour
 (centrage horizontal)	ajuster le centrage horizontal de l'image
 (centrage vertical)	ajuster le centrage vertical de l'image
 (dimension horizontale)	ajuster la dimension horizontale de l'image
 (dimension verticale)	ajuster la dimension verticale de l'image
 (zoom)	agrandir ou réduire l'image

- 4 Appuyez sur les touches ←/→ pour ajuster les réglages.



Sélectionnez	Pour
 (centrage horizontal)	→ ... déplacer l'image vers la droite ← ... déplacer l'image vers la gauche
 (centrage vertical)	→ ... déplacer l'image vers le haut ← ... déplacer l'image vers le bas
 (dimension horizontale)	→ ... augmenter la largeur de l'image ← ... diminuer la largeur de l'image
 (dimension verticale)	→ ... augmenter la hauteur de l'image ← ... diminuer la hauteur de l'image
 (zoom)	→ ... agrandir l'image ← ... réduire l'image

Appuyez une seule fois sur la touche  pour revenir à l'écran MENU, et deux fois pour revenir au mode d'affichage normal. Si vous n'appuyez sur aucune touche, l'écran de menu disparaît automatiquement au bout d'environ 30 secondes.

Pour réinitialiser les valeurs de réglage, appuyez sur la touche  (réinitialisation) pendant que l'écran de menu est affiché.

Le paramètre sélectionné est ramené à la valeur de réglage par défaut.

### Remarque



Le réglage  (zoom) s'arrête lorsque la dimension horizontale ou verticale atteint sa valeur maximale ou minimale. La valeur de réglage horizontal n'est pas affichée dans le menu.

## Utilisation de l'écran de menu GEOMETRIE



La GEOMETRIE vous permet d'ajuster la forme et l'orientation de l'image.  
Dès que  (rotation) est réglé, il sera enregistré en mémoire pour tous les signaux d'entrée reçus. Tous les autres réglages seront mémorisés pour le signal d'entrée en cours.

- 1 Appuyez sur la touche .  
L'écran MENU apparaît.



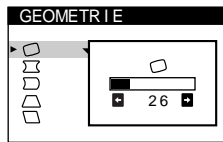
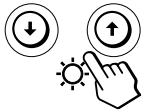



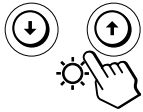

- 2 Appuyez sur les touches / pour sélectionner "GEOMETRIE" et appuyez de nouveau sur la touche .  
L'écran de menu GEOMETRIE apparaît.











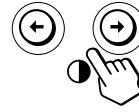







- 3 Appuyez sur les touches / pour sélectionner le paramètre que vous voulez régler.





Sélectionnez	Pour
 (rotation)	régler la rotation de l'image
 (distorsion en coussin)	régler les côtés de l'image
 (balance de la distorsion en coussin)	régler la correction cylindrique de l'image
 (distorsion en trapèze)	régler la largeur de l'image
 (balance de la distorsion en trapèze)	régler l'inclinaison de l'image

- 4 Appuyez sur les touches / pour ajuster les réglages.



Pour	Appuyez sur
 (rotation)	<p> ... pour faire pivoter l'image dans le sens horaire</p> <p> ... pour faire pivoter l'image dans le sens antihoraire</p>
 (distorsion en coussin)	<p> ... pour élargir les côtés de l'image</p> <p> ... pour resserrer les côtés de l'image</p>
 (balance de la distorsion en coussin)	<p> ... pour déplacer les côtés de l'image vers la droite</p> <p> ... pour déplacer les côtés de l'image vers la gauche</p>
 (distorsion en trapèze)	<p> ... pour augmenter la largeur de l'image dans le haut</p> <p> ... pour diminuer la largeur de l'image dans le haut</p>
 (balance de la distorsion en trapèze)	<p> ... pour déplacer le haut de l'image vers la droite</p> <p> ... pour déplacer le haut de l'image vers la gauche</p>

Appuyez une seule fois sur la touche  pour revenir à l'écran MENU, et deux fois pour revenir au mode d'affichage normal. Si vous n'appuyez sur aucune touche, l'écran de menu disparaît automatiquement au bout d'environ 30 secondes.

Pour réinitialiser les valeurs de réglage, appuyez sur la touche  (réinitialisation) pendant que l'écran de menu est affiché.



Le paramètre sélectionné est ramené à la valeur de réglage par défaut.

## Utilisation de l'écran de menu COULEUR

Vous pouvez changer la température des couleurs du moniteur. Ainsi, vous pouvez changer les couleurs d'une image à l'écran de façon à ce qu'elles correspondent aux couleurs réelles de l'image imprimée. Une fois le réglage effectué, il sera conservé en mémoire pour tous les signaux d'entrée reçus.

- 1 Appuyez sur la touche . L'écran MENU apparaît.



- 2 Appuyez sur les touches / pour sélectionner "COULEUR" et appuyez de nouveau sur la touche . L'écran de menu COULEUR apparaît.

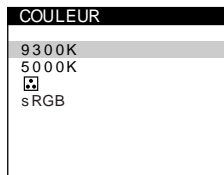
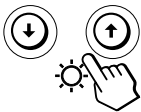



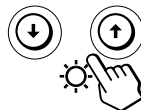

- 3 Appuyez sur les touches / pour sélectionner la température des couleurs.



L'écran vous propose deux modes de température des couleurs.  
Le réglage par défaut est 9.300K.

Sélection de votre propre température des couleurs entre 9.300K et 5.000K

Appuyez sur les touches / pour sélectionner "Variable" et effectuez l'ajustement en appuyant sur les touches /.

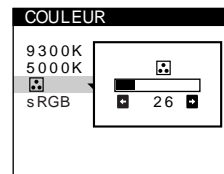
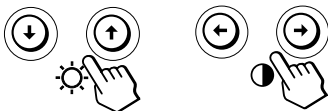





- ➔ ... pour une température plus élevée (vers le bleu)
- ➔ ... pour une température moins élevée (vers le rouge)



Appuyez une seule fois sur la touche  pour revenir à l'écran MENU, et deux fois pour revenir au mode d'affichage normal. Si vous n'appuyez sur aucune touche, l'écran de menu disparaît automatiquement au bout d'environ 30 secondes.

Pour réinitialiser les valeurs de réglage, appuyez sur la touche  (réinitialisation) pendant que l'écran est affiché. La température des couleurs sélectionnée est ramenée à la valeur de réglage par défaut.

### Mode sRGB

Le réglage de couleur sRGB est un protocole d'espace couleur standard conçu pour corréler les couleurs affichées et imprimées des systèmes informatiques compatibles avec sRGB. Pour ajuster les couleurs suivant le profil sRGB, réglez simplement sRGB "ON" dans le menu COULEUR. Pour pouvoir afficher correctement les couleurs sRGB ( $\gamma = 2,2, 6500K$ ), vous devez cependant configurer votre ordinateur suivant le profil sRGB.

Lorsque vous réglez sRGB sur "ON" pour le réglage de la couleur, la luminosité () et le contraste () se règlent automatiquement sur "31" et "85". Si vous changez le réglage de la luminosité () et du contraste (), le réglage sRGB passe à "OFF".

Pour plus de détails sur le changement des réglages de la luminosité () et du contraste (), voir page 6.

### Remarque

Votre ordinateur et les autres appareils raccordés (une imprimante, par exemple) doivent être compatibles avec sRGB.

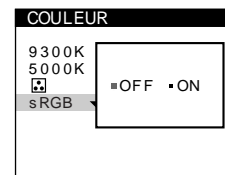

## Utilisation de l'écran de menu

### CONVERGENCE

Les réglages CONVERGENCE permettent de régler la qualité de l'image en contrôlant la convergence. La convergence est l'alignement des signaux de couleur rouge, vert et bleu.

Si vous voyez des ombres rouges ou bleues autour des lettres ou des lignes, réglez la convergence.

Une fois que le réglage est effectué, il sera conservé en mémoire pour tous les signaux d'entrée reçus.

#### 1 Appuyez sur la touche .

L'écran MENU apparaît.



#### 2 Appuyez sur les touches ↓/↑ pour sélectionner "CONVERGENCE" et appuyez de nouveau sur la touche .

L'écran de menu CONVERGENCE apparaît.

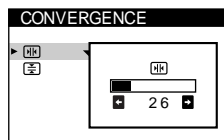
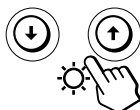

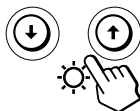

#### 3 Appuyez sur les touches ↓/↑ pour sélectionner le paramètre à régler.

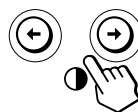

#### 4 Appuyez sur les touches ←/→ pour ajuster les réglages.





Pour	Appuyez sur
 (Convergence horizontale)	<p>→ ... pour décaler les ombres rouges vers la droite et les ombres bleues vers la gauche</p> <p>← ... pour décaler les ombres rouges vers la gauche et les ombres bleues vers la droite</p>
 (Convergence verticale)	<p>→ ... pour décaler les ombres rouges vers le haut et les ombres bleues vers le bas</p> <p>← ... pour décaler les ombres rouges vers le bas et les ombres bleues vers le haut</p>

Appuyez une seule fois sur la touche  pour revenir à l'écran MENU, et deux fois pour revenir au mode d'affichage normal. Si vous n'appuyez sur aucune touche, l'écran de menu disparaît automatiquement au bout d'environ 30 secondes.

Pour réinitialiser les valeurs de réglage, appuyez sur la touche  (réinitialisation) pendant que l'écran de menu est affiché.

Le paramètre sélectionné est ramené à la valeur de réglage par défaut.

Sélectionnez	Pour
 (Convergence horizontale)	réglage la convergence horizontale
 (Convergence verticale)	réglage la convergence verticale



## Utilisation de l'écran de menu LANGUAGE

Les écrans de menu sont disponibles en anglais, en français, en allemand, en espagnol, en italien, en néerlandais, en suédois, en russe et en japonais.

- 1 Appuyez sur la touche .  
L'écran MENU apparaît.



- 2 Appuyez sur les touches ↓/↑ pour sélectionner "LANGUAGE" et appuyez de nouveau sur la touche .  
L'écran de menu LANGUAGE apparaît.

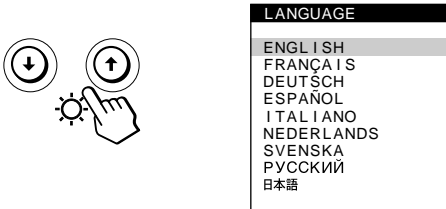

- 3 Appuyez sur les touches ↓/↑ pour sélectionner la langue d'affichage de votre choix.

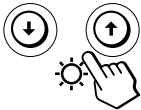

- ENGLISH: Anglais
- FRANÇAIS
- DEUTSCH: Allemand
- ESPAÑOL: Espagnol
- ITALIANO: Italien
- NEDERLANDS: Néerlandais
- SVENSKA: Suédois
- РУССКИЙ: Russe
- 日本語: Japonais

Appuyez une seule fois sur la touche  pour revenir à l'écran MENU, et deux fois pour revenir au mode d'affichage normal. Si vous n'appuyez sur aucune touche, l'écran de menu disparaît automatiquement au bout d'environ 30 secondes.

Pour réinitialiser les valeurs de réglage, appuyez sur la touche  (réinitialisation) pendant que l'écran de menu est affiché.

## Utilisation de l'écran de menu OPTION

L'écran de menu OPTION vous permet de démagnétiser manuellement l'écran, d'ajuster le niveau d'annulation de moiré et de régler la position du menu sur écran. Il permet également de verrouiller les commandes.

### Démagnétisation de l'écran

L'écran du moniteur est automatiquement démagnétisé à la mise sous tension.

Vous pouvez aussi démagnétiser manuellement l'écran.

- 1 Appuyez sur la touche .  
L'écran MENU apparaît.



- 2 Appuyez sur les touches ↓/↑ pour sélectionner "OPTION" et appuyez de nouveau sur la touche .  
L'écran de menu OPTION apparaît.

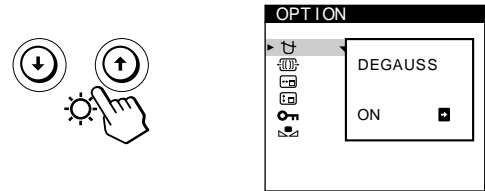

- 3 Appuyez sur les touches ↓/↑ pour sélectionner "DEGAUSS".

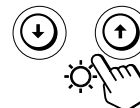

- 4 Appuyez sur la touche .  
L'écran est démagnétisé pendant environ 5 secondes.

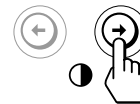

Si vous devez démagnétiser l'écran une seconde fois, attendez au moins 20 minutes avant de répéter cette procédure.



Appuyez une seule fois sur la touche  pour revenir à l'écran MENU, et deux fois pour revenir au mode d'affichage normal. Si vous n'appuyez sur aucune touche, l'écran de menu disparaît automatiquement au bout d'environ 30 secondes.

## Ajustement du moiré



Si des lignes elliptiques ou ondulées apparaissent à l'écran, ajustez le niveau d'annulation de moiré.

- 1 Appuyez sur la touche .  
L'écran MENU apparaît.



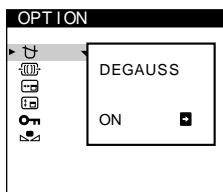
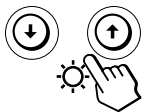

- 2 Appuyez sur les touches / pour sélectionner "OPTION" et appuyez de nouveau sur la touche .  
L'écran de menu OPTION apparaît.

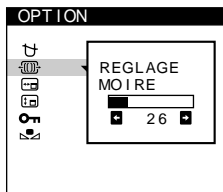
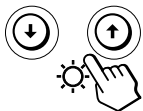

- 3 Appuyez sur les touches / pour sélectionner "REGLAGE MOIRE\*."  
"REGLAGE MOIRE\*."



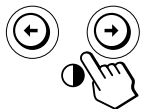

- 4 Appuyez sur les touches / pour régler le degré d'annulation de moiré jusqu'à ce que l'effet de moiré soit au minimum.

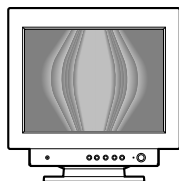

\* Le moiré est un type d'interférence naturelle qui produit de fines lignes ondulées à l'écran. Il peut apparaître en raison d'une interférence entre le motif de l'image à l'écran et le pas des points de luminophores de couleur du moniteur.

Exemple de moiré:



Appuyez une seule fois sur la touche  pour revenir à l'écran MENU, et deux fois pour revenir au mode d'affichage normal. Si vous n'appuyez sur aucune touche, l'écran de menu disparaît automatiquement au bout d'environ 30 secondes.



Pour réinitialiser, appuyez sur la touche  (réinitialisation) pendant que l'écran de menu est affiché.

## Changement de la position d'affichage des écrans de menu



Vous pouvez changer la position d'affichage des écrans de menu (par exemple, lorsque vous voulez régler l'image derrière un écran de menu).

- 1 Appuyez sur la touche .  
L'écran MENU apparaît.

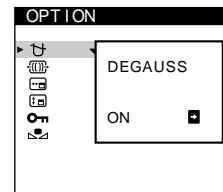
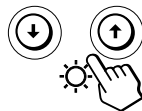

- 2 Appuyez sur les touches / pour sélectionner "OPTION" et appuyez de nouveau sur la touche .  
L'écran de menu OPTION apparaît.



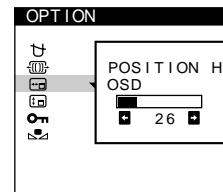
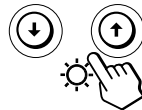

- 3 Appuyez sur les touches / pour sélectionner "POSITION H OSD" ou "POSITION V OSD". Sélectionnez "POSITION H OSD" pour ajuster la position horizontale.



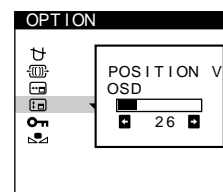
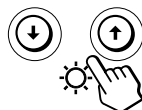

Sélectionnez "POSITION V OSD" pour ajuster la position verticale.

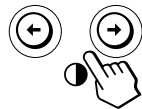

- 4 Appuyez sur les touches / pour amener l'écran de menu à la position voulue.



Appuyez une seule fois sur la touche  pour revenir à l'écran MENU, et deux fois pour revenir au mode d'affichage normal. Si vous n'appuyez sur aucune touche, l'écran de menu disparaît automatiquement au bout d'environ 30 secondes.

Pour réinitialiser les valeurs de réglage, appuyez sur la touche  (réinitialisation) pendant que l'écran de menu est affiché.

## Verrouillage des commandes

Vous pouvez protéger les données de réglage en verrouillant les commandes.

- 1 Appuyez sur la touche .  
L'écran MENU apparaît.



- 2 Appuyez sur les touches ↓/↑ pour sélectionner "OPTION" et appuyez de nouveau sur la touche .  
L'écran de menu OPTION apparaît.

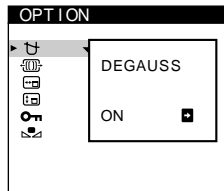
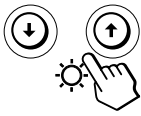

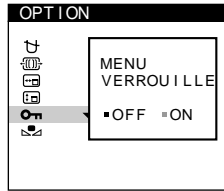
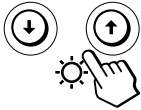

- 3 Appuyez sur les touches ↓/↑ pour sélectionner "MENU VERROUILLE".

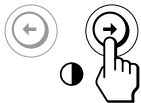

- 4 Appuyez sur la touche → pour sélectionner "ON".



Appuyez une seule fois sur la touche  pour revenir à l'écran MENU, et deux fois pour revenir au mode d'affichage normal. Si vous n'appuyez sur aucune touche, l'écran de menu disparaît automatiquement au bout d'environ 30 secondes.

Seul le commutateur  (alimentation), SORTIR et "MENU VERROUILLE" du menu "OPTION" seront opérants. Si une autre option est sélectionnée, l'indication  apparaît à l'écran.

### Pour annuler le verrouillage des commandes

Répétez les étapes 1 à 3 au-dessus et appuyez sur la touche ← pour sélectionner "OFF".

## Restauration des couleurs

Les couleurs de la plupart des moniteurs tendent à perdre progressivement de leur éclat au fil des ans. La fonction RESTAURER COULEUR vous permet de restaurer les couleurs aux niveaux de qualité par défaut d'origine. Les explications ci-dessous présentent comment restaurer les couleurs du moniteur.

- 1 Appuyez sur la touche .  
L'écran MENU apparaît.



- 2 Appuyez sur les touches ↓/↑ pour sélectionner "OPTION" et appuyez de nouveau sur la touche .  
L'écran de menu OPTION apparaît.

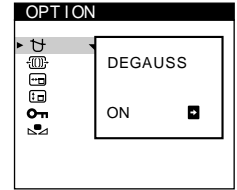
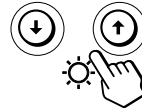

- 3 Appuyez sur les touches ↓/↑ pour sélectionner "RESTAURER COULEUR".

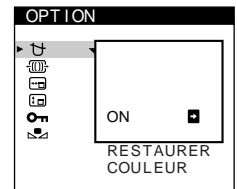
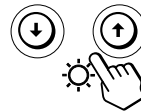

- 4 Appuyez sur la touche → pour sélectionner "ON".

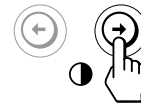

L'image disparaît tandis que les couleurs sont restaurées (environ 2 secondes). Après que les couleurs ont été restaurées, l'image réapparaît à l'écran.

Appuyez une seule fois sur la touche  pour revenir à l'écran MENU, et deux fois pour revenir au mode d'affichage normal. Si vous n'appuyez sur aucune touche, l'écran de menu disparaît automatiquement au bout d'environ 30 secondes.

## Remarques

- Avant d'utiliser cette fonction, le moniteur doit se trouver en mode de fonctionnement normal (indicateur d'alimentation vert allumé) depuis au moins 30 minutes. Si le moniteur passe en mode d'économie d'énergie, vous devez ramener le moniteur en mode de fonctionnement normal et attendre 30 minutes pour que le moniteur soit prêt.

Il se peut que vous deviez ajuster les réglages d'économie d'énergie de votre ordinateur de manière à garder le moniteur en mode de fonctionnement normal pendant au moins 30 minutes. Si le moniteur n'est pas prêt, le message suivant apparaît.

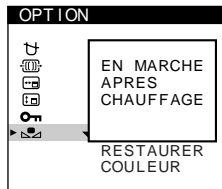



- Le moniteur peut progressivement perdre sa capacité à exécuter cette fonction en raison du vieillissement naturel du tube image.

## Utilisation de l'écran de menu AIDE



Le menu AIDE contient des conseils et informations utiles concernant ce moniteur. Si votre moniteur présente des symptômes semblables à ceux indiqués dans le menu AIDE, suivez les instructions à l'écran pour résoudre le problème. Si les symptômes n'apparaissent pas dans le menu AIDE ou si le problème persiste, voir "Guide de dépannage" à la page 18.

- Appuyez sur la touche .  
L'écran MENU apparaît.

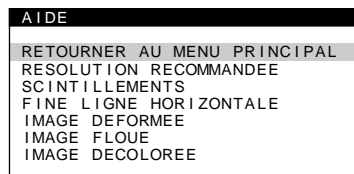
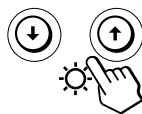

- Appuyez sur les touches / pour sélectionner "AIDE" et appuyez de nouveau sur la touche .  
Le menu AIDE apparaît.



- Appuyez sur les touches / pour sélectionner une option du menu HELP.

Les instructions ou les informations permettant de résoudre le problème apparaissent à l'écran. Une explication de chaque option de menu est donnée ci-dessous.

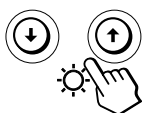

## RESOLUTION RECOMMANDEE

Si l'image ne remplit pas l'écran jusqu'aux bords ou si l'image apparaît trop grande pour l'écran, réglez la résolution sur votre ordinateur en fonction des chiffres donnés dans le menu. Si le signal d'entrée correspond à l'un des modes présélectionnés de ce moniteur, la résolution et le taux de régénération du signal d'entrée en cours sont affichées.

## SCINTILLEMENTS

Si l'image scintille, réglez le taux de régénération selon les chiffres indiqués dans le menu. Si le signal d'entrée correspond à l'un des modes présélectionnés de ce moniteur, le taux de régénération du signal d'entrée en cours est affiché.

## FINE LIGNE HORIZONTALE

Les lignes qui apparaissent sur l'écran sont des fils d'amortissement. Voir page 16 pour plus d'informations sur les fils d'amortissement.



## IMAGE DEFORMEE

Si la forme de l'image à l'écran semble distordue, essayez de régler la géométrie de l'image. Appuyez sur la touche  pour passer directement à l'écran de menu GEOMETRIE.

## IMAGE FLOUE

L'image peut paraître floue lorsque les signaux rouge et bleu ne sont pas correctement alignés, provoquant l'apparition d'ombres rouges ou bleues autour des lettres et des lignes. Essayez de régler la convergence de l'image pour faire disparaître ces ombres. Appuyez sur la touche  pour passer directement à l'écran de menu CONVERGENCE. Lorsque le menu CONVERGENCE est affiché, les réglages du contraste, de la luminosité et du moiré sont automatiquement réinitialisés pour tous les signaux d'entrée.



## IMAGE DECOLOREE

Si la couleur de l'image semble anormale dans certaines zones de l'écran, commencez par vérifier que les câbles de signaux sont correctement branchés. Cela fait, essayez de démagnétiser l'écran manuellement. Appuyez sur la touche  pour passer directement à l'écran de menu OPTION, puis sélectionnez  (DEGAUSS).

Appuyez une seule fois sur la touche  pour revenir à l'écran MENU, et deux fois pour revenir au mode d'affichage normal. Si vous n'appuyez sur aucune touche, l'écran de menu disparaît automatiquement au bout d'environ 30 secondes.

## Réinitialisation des réglages

### Réinitialisation d'un paramètre de réglage

- 1 Appuyez sur les touches  et  pour sélectionner l'écran de menu contenant le paramètre que vous voulez réinitialiser et appuyez ensuite de nouveau sur la touche .



- 2 Appuyez sur les touches  pour sélectionner le paramètre que vous voulez réinitialiser.

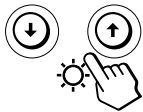

- 3 Appuyez sur la touche  (réinitialisation).

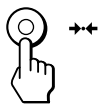

### Réinitialisation de toutes les données de réglage pour le signal d'entrée en cours

Alors qu'aucun écran de menu n'est affiché, appuyez sur la touche  (réinitialisation).

Toutes les données de réglage pour le signal d'entrée en cours sont ramenées aux valeurs de réglage par défaut. Sachez que la réinitialisation du signal en cours n'affecte pas la luminosité et le contraste, la langue d'affichage sur écran, la position sur écran et le verrouillage des commandes.

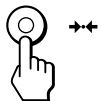



### Réinitialisation de toutes les données de réglage pour tous les signaux d'entrée

Maintenez la touche  (réinitialisation) enfoncée pendant au moins deux secondes.

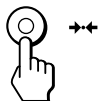
Toutes les données de réglage, y compris la luminosité et le contraste, sont ramenées aux valeurs de réglage par défaut.



#### Remarque

La touche  (réinitialisation) ne fonctionne pas lorsque  (MENU VERROUILLE) est mis sur ON.

## Fonction d'économie d'énergie

Ce moniteur répond aux directives d'économie d'énergie établies par VESA et ENERGY STAR, ainsi qu'aux normes plus sévères de NUTEK.

Si le moniteur est raccordé à un ordinateur ou à une carte graphique vidéo compatible VESA DPMS (Display Power Management Signaling), le moniteur réduira automatiquement la consommation de courant en trois étapes, comme indiqué ci-dessous.

- Lorsque votre ordinateur est en mode d'économie d'énergie, MONITEUR EN MODE D'ECONOMIE D'ENERGIE apparaît à l'écran si vous appuyez sur n'importe quelle touche du moniteur (page 17). Après quelques secondes, le moniteur repasse en mode d'économie d'énergie. Une fois que les signaux de synchronisation horizontale et verticale sont détectés, le moniteur reprend automatiquement son mode de fonctionnement normal.
- La fonction de gestion de l'énergie est activée lorsque l'ordinateur reconnaît que vous n'avez pas utilisé la souris ou le clavier pendant une durée déterminée par l'utilisateur.
- IBM vous conseille de mettre votre moniteur hors tension à la fin de chaque journée de travail ou lorsque vous prévoyez de ne pas l'utiliser pendant une période prolongée durant la journée.

Mode de consommation d'énergie	Ecran	Signal synchro horizontal	Signal synchro vertical	Consommation électrique	Temps de reprise	Indicateur 
1 Fonctionnement normal	actif	présent	présent	≤ 140 W	—	Vert
2 Veille (1er mode)	inactif	absent	présent	≤ 15 W	Approx. 5 s	Vert et orange en alternance
3 Interruption (2e mode) (sommeil)*	inactif	présent	absent	≤ 15 W	Approx. 5 s	Vert et orange en alternance
4 Inactif (3e mode) (sommeil profond)*	inactif	absent	absent	≤ 3 W	Approx. 15 s	Orange
5 Hors tension	—	—	—	≤ 0,5 W	—	Désactivé

\* "Sommeil" et "sommeil profond" sont des modes d'économie d'énergie définis par l'Environmental Protection Agency.

## Fils d'amortissement

Sur un fond blanc, il se peut que vous observiez sur l'écran de très fines lignes horizontales comme illustré ci-dessous. Il s'agit des ombres des fils d'amortissement. Ce phénomène est typique pour les tubes cathodiques, qui utilisent des grilles d'ouverture. Les fils d'amortissement sont fixés à la grille d'ouverture à l'intérieur du tube Trinitron de façon à amortir les vibrations de la grille d'ouverture.

Fils d'amortissement

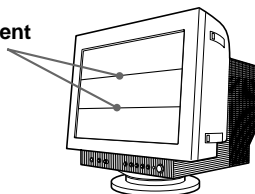

## Un moniteur prêt à l'emploi ("Plug & Play")

Ce moniteur satisfait aux normes DDC1, DDC2B et DDC2Bi Display Data Channel (DDC) de VESA.

Si un serveur DDC1 est raccordé, le moniteur se synchronise sur V. CLK conformément aux normes VESA et sort l'EDID (Extended Display Identification Data) vers la ligne de données.

Lorsqu'un système hôte DDC2B ou DDC2Bi est raccordé, le moniteur passe automatiquement au standard approprié.

### Modes présélectionnés

N°	Résolution (points × lignes)	Fréquence horizontale	Fréquence verticale	Mode graphique
1	640 × 480	31,5 kHz	60 Hz	VGA
2	640 × 480	43,3 kHz	85 Hz	VESA
3	800 × 600	46,9 kHz	75 Hz	VESA
4	800 × 600	53,7 kHz	85 Hz	VESA
5	1024 × 768	60,0 kHz	75 Hz	VESA
6	1024 × 768	68,7 kHz	85 Hz	VESA
7	1280 × 1024	80,0 kHz	75 Hz	VESA
8	1280 × 1024	91,1 kHz	85 Hz	VESA
9	1600 × 1200	93,8 kHz	75 Hz	VESA
10	1600 × 1200	106,3 kHz	85 Hz	VESA

### Affichage des informations sur le moniteur

Vous pouvez afficher la désignation du modèle, le numéro de série et l'année de fabrication à l'aide de l'écran de menu **INFORMATIONS** du moniteur.

Maintenez la touche  enfoncée pendant 3 secondes. L'écran de menu **INFORMATIONS** apparaît.

Exemple:



INFORMATIONS
MODEL : IBM P96
SER NO : 12 - 34567
MANUFACTURED : 1999 - 52

L'écran de menu **INFORMATIONS** mentionne la désignation du modèle, le numéro de série et l'année de fabrication.

L'écran de menu disparaît automatiquement au bout de 30 secondes.

### Messages d'avertissement

Si aucune image n'apparaît à l'écran, l'un des messages suivants s'affiche. Pour remédier au problème, voir "Guide de dépannage" à la page 18.

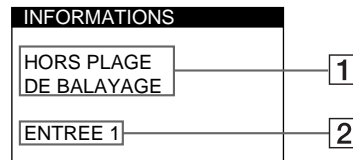

#### 1 Condition du signal d'entrée

##### HORS PLAGE DE BALAYAGE

indique que le signal d'entrée n'est pas supporté par les spécifications du moniteur.

##### PAS ENTREE VIDEO

indique qu'aucun signal n'est entré.

##### MONITEUR EN MODE D'ECONOMIE D'ENERGIE

indique que l'ordinateur est en mode d'économie d'énergie.







Ce message ne s'affiche que lorsque votre ordinateur se trouve dans un mode d'économie d'énergie et que vous appuyez sur l'une des touches du moniteur.

#### 2 Le connecteur sélectionné

Ce message indique le connecteur sélectionné (ENTREE 1 ou ENTREE 2)

## Guide de dépannage

Cette section peut vous aider à localiser un problème et, par conséquent, vous éviter de consulter un service technique.

Symptôme	Vérifiez
<b>Pas d'image</b>	
Si l'indicateur  n'est pas allumé	<ul style="list-style-type: none"> <li>• Vérifiez si le cordon d'alimentation est correctement branché.</li> <li>• Vérifiez que l'interrupteur  (alimentation) est réglé sur la position "on".</li> </ul>
Si le message "PAS ENTREE VIDEO" apparaît à l'écran ou si l'indicateur  est orange ou passe alternativement de l'orange au vert	<ul style="list-style-type: none"> <li>• Vérifiez si l'interrupteur d'alimentation de votre ordinateur est réglé sur la position "on".</li> <li>• Vérifiez si le réglage du commutateur INPUT 1-2 est correct (page 5).</li> <li>• Vérifiez si le câble de signal vidéo est correctement branché et si toutes les fiches sont fermement enfoncées dans les prises.</li> <li>• Assurez-vous qu'aucune broche n'est pliée ou enfoncée dans le connecteur d'entrée vidéo.</li> <li>• Assurez-vous que la carte graphique est bien logée dans la fente de bus adéquate.</li> </ul>
Si le message "MONITEUR EN MODE D'ECONOMIE D'ENERGIE" apparaît à l'écran, ou si l'indicateur  est allumé en orange ou alterne entre le vert et l'orange	<ul style="list-style-type: none"> <li>• L'ordinateur est en mode d'économie d'énergie. Appuyez sur une touche quelconque du clavier de l'ordinateur ou déplacez la souris.</li> <li>• Vérifiez que le commutateur d'alimentation de votre ordinateur est en position "on".</li> <li>• Assurez-vous que la carte graphique est bien logée dans la fente de bus adéquate.</li> </ul>
Si le message "HORS PLAGE DE BALAYAGE" apparaît à l'écran	<ul style="list-style-type: none"> <li>• Vérifiez si la plage de fréquence vidéo est conforme à la plage spécifiée pour le moniteur. (Horizontal.: 30 – 107 kHz Vertical.: 48 – 120 Hz) Reportez-vous au mode d'emploi de votre ordinateur pour régler la plage de fréquence vidéo.</li> <li>• Si vous utilisez un adaptateur de câble de signal vidéo, vérifiez s'il est correct.</li> </ul>
Si aucun message n'est affiché et si l'indicateur  est vert ou clignote en orange	<ul style="list-style-type: none"> <li>• Voir "Fonction d'autodiagnostic" (page 20).</li> </ul>
<b>L'image est brouillée.</b>	<ul style="list-style-type: none"> <li>• Consultez le mode d'emploi de votre carte graphique pour le réglage approprié du moniteur.</li> <li>• Consultez ce mode d'emploi et vérifiez si le mode graphique et la fréquence que vous essayez d'utiliser sont supportés. Même si la fréquence est comprise dans la plage adéquate, certaines cartes graphiques peuvent présenter une impulsion de synchronisation trop étroite pour que le moniteur se synchronise correctement.</li> </ul>
<b>Les couleurs ne sont pas uniformes</b>	<ul style="list-style-type: none"> <li>• Démagnétisez le moniteur (page 11). Si vous placez près du moniteur un appareil qui génère un champ magnétique comme un haut-parleur ou si vous changez l'orientation du moniteur, il est possible que les couleurs perdent leur uniformité. Cette fonction sert à démagnétiser le cadre métallique du tube cathodique de façon à obtenir un champ neutre pour une reproduction uniforme des couleurs. Si un second cycle de démagnétisation est nécessaire, laissez s'écouler un intervalle d'au moins 20 minutes pour obtenir les meilleurs résultats.</li> </ul>
<b>Vous ne parvenez pas à régler le moniteur à l'aide des touches du panneau frontal ( apparaît sur l'écran)</b>	<ul style="list-style-type: none"> <li>• Si la fonction de verrouillage des commandes est activée, mettez-la sur OFF dans le menu OPTION (page 13).</li> </ul>
<b>Le blanc n'est pas blanc</b>	<ul style="list-style-type: none"> <li>• Ajustez la température de couleur (page 9).</li> </ul>



Symptôme	Vérifiez
L'image à l'écran n'est pas centrée ou dimensionnée correctement	<ul style="list-style-type: none"> <li>Appuyez sur la touche  (page 5).</li> <li>Réglez le centrage ou la taille de l'image (page 7). Certains modes vidéo ne remplissent pas l'écran jusqu'aux bords. Ce problème a tendance à se produire avec certaines cartes graphiques.</li> </ul>
Les bords de l'image sont incurvés	<ul style="list-style-type: none"> <li>Réglez la géométrie (page 8).</li> </ul>
Le rebord des lignes blanches est ombré de rouge ou de bleu	<ul style="list-style-type: none"> <li>Réglez la convergence (page 10).</li> </ul>
L'image est floue	<ul style="list-style-type: none"> <li>Réglez le contraste et la luminosité (page 6).</li> <li>Démagnétisez le moniteur (page 11). Si vous placez près du moniteur un appareil qui génère un champ magnétique comme un haut-parleur ou si vous changez l'orientation du moniteur, il est possible que les couleurs perdent leur uniformité. Cette fonction sert à démagnétiser le cadre métallique du tube cathodique de façon à obtenir un champ neutre pour une reproduction uniforme des couleurs. Si un second cycle de démagnétisation est nécessaire, laissez s'écouler un intervalle d'au moins 20 minutes pour obtenir les meilleurs résultats.</li> <li>Si le contour des images est ombré de bleu ou de rouge, procédez au réglage de la convergence (page 10).</li> <li>Sélectionnez SUPPRIMER MOIRE et ajustez l'effet d'annulation de moiré (page 12).</li> </ul>
L'image sautille ou oscille fortement	<ul style="list-style-type: none"> <li>Isolez et éliminez toute source potentielle de champs électriques ou magnétiques. C'est généralement le cas des ventilateurs électriques, des éclairages fluorescents, des imprimantes laser.</li> <li>Si un autre moniteur se trouve à proximité de celui-ci, éloignez-le de façon à réduire les interférences.</li> <li>Branchez le moniteur sur une autre prise d'alimentation, de préférence sur un circuit différent.</li> <li>Essayez le moniteur sur un ordinateur différent dans une autre pièce.</li> </ul>
L'image scintille	<ul style="list-style-type: none"> <li>Réglez le taux de régénération de l'ordinateur pour obtenir la meilleure image possible en vous référant au mode d'emploi de l'ordinateur.</li> </ul>
Apparition d'images fantômes	<ul style="list-style-type: none"> <li>Si ce symptôme se manifeste, débranchez les câbles prolongateurs vidéo et/ou les boîtiers de commutation vidéo. Une longueur de câble excessive ou des connexions lâches peuvent être à l'origine de l'apparition de ce symptôme.</li> </ul>
Apparition d'un motif ondulateur ou elliptique (moiré)	<ul style="list-style-type: none"> <li>Sélectionnez SUPPRIMER MOIRE et ajustez l'effet d'annulation de moiré (page 12). Le moiré peut varier suivant l'ordinateur connecté.</li> <li>Modifiez le motif de votre bureau. En raison du rapport entre la résolution, le pas de point du moniteur et le pas de certains motifs d'image, certains arrière-plans d'écran peuvent parfois afficher du moiré.</li> </ul>
Deux fines lignes horizontales (fils) sont visibles	<ul style="list-style-type: none"> <li>Ces fils stabilisent la grille d'ouverture rayée verticalement (page 16). Cette grille d'ouverture permet le passage de plus de lumière au travers de l'écran, ce qui confère au tube cathodique Trinitron des couleurs plus denses et une luminosité plus intense.</li> </ul>
La fonction RESTAURER COULEUR est inopérante	<ul style="list-style-type: none"> <li>Avant d'utiliser cette fonction, le moniteur doit se trouver en mode de fonctionnement normal (indicateur d'alimentation vert allumé) depuis au moins 30 minutes. Pour plus d'informations sur l'utilisation de la fonction RESTAURER COULEUR, reportez-vous à "Restauration des couleurs" (page 13).</li> <li>Ajustez les réglages du mode d'économie d'énergie de l'ordinateur de façon à garder le moniteur en mode de fonctionnement normal pendant plus de 30 minutes.</li> <li>Le moniteur peut progressivement perdre sa capacité à exécuter cette fonction en raison du vieillissement naturel du tube image.</li> </ul>
Un souffle est audible juste après la mise sous tension	<ul style="list-style-type: none"> <li>Le cycle de démagnétisation est activé à la mise sous tension. Pendant que le cycle de démagnétisation est activé, un souffle peut se faire entendre. Ce même souffle est audible lors de la démagnétisation manuelle. Il ne s'agit pas d'un dysfonctionnement.</li> </ul>

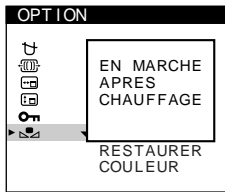

• Si le problème persiste, appelez le IBM HelpCenter.

Aux Etats-Unis, formez le 1-800-772-2227

Au Canada, formez le 1-800-565-3344



• Notez le nom de modèle et le numéro de série de votre moniteur. De même, notez le fabricant et le nom de votre ordinateur et de votre carte graphique.

### Fonction d'autodiagnostic

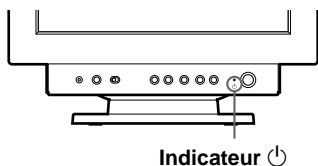
Ce moniteur est équipé d'une fonction d'auto-diagnostic. S'il y a un problème avec votre moniteur ou l'ordinateur, l'écran deviendra vierge et l'indicateur  s'allumera en vert ou clignotera en orange.



#### Si l'indicateur est vert

- 1 Déconnectez le câble d'entrée vidéo ou mettez l'ordinateur raccordé hors tension.
- 2 Appuyez deux fois sur la touche  pour éteindre le moniteur, puis pour le remettre sous tension.
- 3 Appuyez sur la touche  et maintenez-la enfoncée pendant 2 secondes avant que le moniteur ne passe en mode d'économie d'énergie.





Si les quatre barres de couleur apparaissent (blanc, rouge, vert, bleu), c'est que le moniteur fonctionne correctement. Rebranchez le câble d'entrée vidéo et vérifiez l'état de votre ordinateur.

Si les barres de couleur n'apparaissent pas, c'est qu'il y a une défaillance potentielle du moniteur. Informez le IBM HelpCenter de la condition de votre moniteur.

#### Si l'indicateur clignote en orange

Appuyez deux fois sur la touche  pour éteindre le moniteur, puis pour le remettre sous tension.

Si l'indicateur  apparaît en vert, c'est que le moniteur fonctionne correctement.

Si l'indicateur  clignote toujours, c'est probablement dû à une défaillance de votre moniteur. Informez le IBM HelpCenter de la condition de votre moniteur. N'oubliez pas de consigner la désignation du modèle et le numéro de série de votre moniteur. Consignez également la désignation du modèle et le fabricant de votre ordinateur et de votre carte vidéo.

### Spécifications

Tube image	Pas d'ouverture de grille de 0,24 mm 19 pouces mesurés en diagonale Déflexion de 90 degrés
Taille de l'image affichée	Approx. 365 × 274 mm (l/h) Zone de visualisation de 18,0"
Résolution	Horizontale : Max. 1600 points Verticale : Max. 1200 lignes
Zone d'image standard	Approx. 352 × 264 mm (l/h)
Fréquence de déflexion*	Horizontale : 30 à 107 kHz Verticale : 48 à 120 Hz 256 < Total de Lignes < 2048
Tension/courant CA d'entrée	100 à 240 V, 50 – 60 Hz, Max. 2,0 A
Consommation électrique	Max. 140 W
Température d'utilisation	10°C à 40°C
Dimensions	Approx. 462 × 462 × 474 mm (l/h/p)
Masse	Approx. 27 kg

- \* Condition de synchronisation horizontale et verticale
- La largeur de synchronisation horizontale doit être supérieure à 1,0 µsec.
  - La largeur de suppression horizontale doit être supérieure à 3,0 µsec.
  - La largeur de suppression verticale doit être supérieure à 450 µsec.

La conception et les spécifications sont sujettes à modifications sans préavis.

**Deutsch**

# Ausgabe 1

Die Angaben in diesem Handbuch werden in regelmäßigen Zeitabständen aktualisiert. Die Änderungen werden in Überarbeitungen oder in Technical News Letters (TNLs) bekanntgegeben. IBM kann jederzeit Verbesserungen und/oder Änderungen an den in dieser Veröffentlichung beschriebenen Produkten und/oder Programmen vornehmen.

Dieses Handbuch kann Verweise auf oder Informationen über IBM-Produkte, -Programme oder -Dienstleistungen enthalten, die nicht in allen Ländern angekündigt sind.

Anfragen nach weiteren Exemplaren dieser Veröffentlichung und über technische Angaben zu IBM-Produkten sind an den zuständigen IBM-Ansprechpartner zu richten.

Diese Veröffentlichung darf ohne vorherige schriftliche Genehmigung von IBM weder ganz noch in Auszügen vervielfältigt oder vertrieben werden.

Hinweise auf IBM-Produkte, Programme und Dienstleistungen in dieser Veröffentlichung bedeuten nicht, daß IBM diese in allen Ländern, in denen IBM vertreten ist, anbietet. Hinweise auf IBM-Lizenzprogramme oder andere IBM-Produkte bedeuten nicht, daß nur Programme, Produkte oder Dienstleistungen von IBM verwendet werden können. Anstelle der IBM-Produkte, -Programme oder -Dienstleistungen können auch andere ihnen äquivalente Produkte, Programme oder Dienstleistungen verwendet werden, solange diese keine gewerblichen oder anderen Schutzrechte von IBM verletzen. Die Verantwortung für den Betrieb der Produkte, Programme oder Dienstleistungen in Verbindung mit Fremdprodukten und Fremdleistungen liegt beim Kunden, soweit solche Verbindungen nicht ausdrücklich von IBM bestätigt sind.

Für in diesem Handbuch beschriebene Erzeugnisse und Verfahren kann es IBM-Patente oder -Patentanmeldungen geben. Mit der Auslieferung dieses Handbuchs ist keine Lizenzierung dieser Patente verbunden.

## Marken

Folgende Namen sind in gewissen Ländern Marken oder Dienstleistungsmarken der IBM Corporation:

### **IBM VGA HelpCenter**

- ENERGY STAR ist ein eingetragenes Warenzeichen in den USA.
- Trinitron® ist ein eingetragenes Warenzeichen der Sony Corporation.
- DDC™ ist ein Warenzeichen der Video Electronics Standard Association.
- VESA ist ein Warenzeichen der Video Electronics Standard Association.
- Alle anderen in diesem Handbuch erwähnten Produktnamen können Warenzeichen oder eingetragene Warenzeichen der jeweiligen Eigentümer sein.
- Im Handbuch sind die Warenzeichen und eingetragenen Warenzeichen nicht ausdrücklich durch „™“ bzw. „®“ gekennzeichnet.

© Copyright International Business Machines Corporation 1999.  
Alle Rechte vorbehalten.

# INHALT

---

## Vorbereitungen

Sicherheitsmaßnahmen .....	2
Lage und Funktion der Teile und Bedienelemente .....	3
Anschließen des Geräts .....	4
Auswählen des Eingangssignals .....	5
Automatisches Einstellen der Größe und Zentrierung des Bildes .....	5

---

## Einstellen des Monitors

Auswählen der Sprache für die Bildschirmanzeigen .....	6
Einstellen von Bildhelligkeit und Kontrast .....	6
Das Bildschirmmenüsystem .....	6
Die Bildschirmanzeige GRÖSSE/BILDLG ⇄ .....	7
Die Bildschirmanzeige GEOMETRIE ∩ .....	8
Die Bildschirmanzeige FARBE ▣ .....	9
Die Bildschirmanzeige KONVERGENZ ✱ .....	10
Die Bildschirmanzeige LANGUAGE A .....	11
Die Bildschirmanzeige OPTION ☒ .....	11
Die Bildschirmanzeige HILFE ⚙ .....	14
Zurücksetzen der Einstellungen .....	15

---

## Technische Merkmale

Energiesparfunktion .....	16
Dämpfungsdrähte .....	16
Plug & Play .....	16
Vordefinierte Modi .....	17
Anzeigen der Monitordaten .....	17

---

## Weitere Informationen

Warnmeldungen .....	17
Störungsbehebung .....	18
Selbstdiagnosefunktion .....	20
Technische Daten .....	20

## Sicherheitsmaßnahmen

### Aufstellung

- Achten Sie auf ausreichende Luftzirkulation, damit sich im Monitor kein Wärmestau bildet. Stellen Sie den Monitor nicht auf Oberflächen wie Teppichen oder Decken oder in der Nähe von Materialien wie Gardinen und Wandbehängen auf, die die Lüftungsöffnungen blockieren könnten.
- Stellen Sie den Monitor nicht in der Nähe von Wärmequellen wie Heizkörpern oder Luftschächten oder an Orten auf, an denen er direktem Sonnenlicht, außergewöhnlich viel Staub, mechanischen Vibrationen oder Stößen ausgesetzt ist.
- Stellen Sie den Monitor nicht in der Nähe anderer Geräte auf, die ein starkes Magnetfeld generieren, wie zum Beispiel ein Transformator oder Hochspannungsleitungen.

### Wartung

- Reinigen Sie Gehäuse, Bedienfeld und Bedienelemente mit einem weichen Tuch, das Sie leicht mit einem milden Reinigungsmittel angefeuchtet haben. Verwenden Sie keine Scheuermittel, Scheuerschwämme oder Lösungsmittel wie Alkohol oder Benzin.
- Berühren Sie die Bildschirmoberfläche nicht mit scharfen, rauhen oder spitzen Gegenständen wie zum Beispiel Kugelschreibern oder Schraubenziehern. Andernfalls könnte die Bildschirmoberfläche zerkratzt werden.
- Reinigen Sie den Bildschirm mit einem weichen Tuch. Wenn Sie ein Glasreinigungsmittel verwenden, achten Sie darauf, daß es keine Antistatik-Lösung oder ähnliche Zusätze enthält, da diese zu Kratzern auf der Beschichtung des Bildschirms führen könnten.

### Transport

Wenn Sie den Monitor zu Reparatur- oder Versandzwecken transportieren müssen, verpacken Sie ihn wieder mit Hilfe der Originalverpackungsmaterialien im Originalkarton.

## Der dreh- und neigbare Ständer

Mit dem dreh- und neigbaren Ständer können Sie den Monitor innerhalb der unten abgebildeten Winkel nach Bedarf einstellen. Um die Mitte des Drehradius des Monitors zu finden, richten Sie die Mitte des Monitorbildschirms an den Zentrierpunkten am Ständer aus.

Stützen Sie den Monitor bitte mit beiden Händen unten ab, wenn Sie ihn drehen oder neigen. Achten Sie darauf, die Finger nicht an der Rückseite des Monitors einzuklemmen, wenn Sie den Monitor nach oben schwenken.

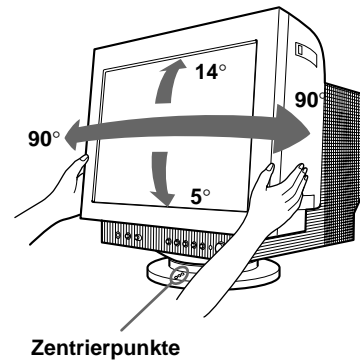

### Hinweis

Nehmen Sie den dreh- und neigbaren Ständer nicht vom Monitor ab.

## Warnhinweis zum Netzanschluß

- Verwenden Sie das für die Stromversorgung in Ihrem Land geeignete Netzkabel.

### Beispiele für Steckertypen:

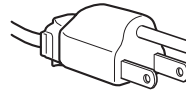

für 100 bis 120 V  
Wechselstrom



für 200 bis 240 V  
Wechselstrom

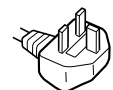

nur für 240 V  
Wechselstrom

- Warten Sie nach dem Ausschalten des Geräts mindestens 30 Sekunden, bevor Sie das Netzkabel lösen. In dieser Zeit kann sich die statische Elektrizität auf der Oberfläche der Kathodenstrahlröhre entladen.
- Wenn Sie das Gerät einschalten, wird die Kathodenstrahlröhre etwa 5 Sekunden lang entmagnetisiert. Dadurch entsteht um das Metallgehäuse der Röhre ein starkes magnetisches Feld, das Daten auf Magnetbändern oder anderen Datenträgern in der Nähe beschädigen kann. Stellen Sie Magnetaufzeichnungsgeräte, Bänder und Disketten daher nicht in der Nähe dieses Monitors ab.

Die Netzsteckdose sollte sich in der Nähe des Geräts befinden und leicht zugänglich sein.

# Lage und Funktion der Teile und Bedienelemente

Weitere Informationen finden Sie auf den in Klammern angegebenen Seiten.

## Vorderseite

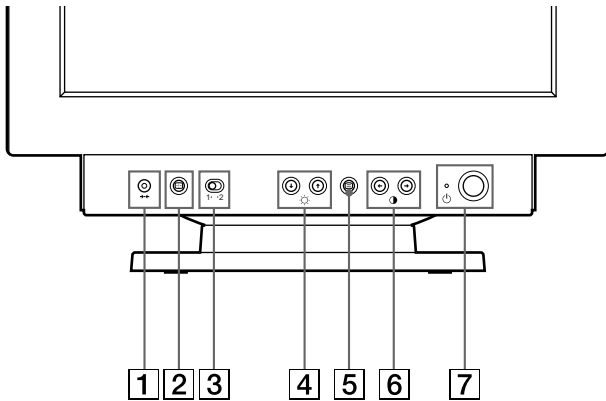

- 1 Taste →← (Zurücksetzen) (Seite 15)**  
Zum Zurücksetzen der Werte auf die werkseitigen Einstellungen.
- 2 Taste Ⓢ (Größe/Zentrierung automatisch einstellen) (Seite 5)**  
Diese Taste dient zum automatischen Einstellen der Größe und Zentrierung der Bilder.
- 3 Schalter INPUT 1-2 (Eingang) (Seite 5)**  
Dieser Schalter dient zum Auswählen des Eingangs INPUT 1 (Videoeingang 1) oder INPUT 2 (Videoeingang 2).
- 4 Tasten ☀ (Helligkeit) ab und auf (↓/↑) (Seite 6-15)**  
Zum Einstellen der Bildhelligkeit.  
Fungieren als die Tasten (↓/↑) zum Einstellen weiterer Optionen.
- 5 Taste ≡ (Menü) (Seite 6-15, 17)**  
Zum Aufrufen der Bildschirmanzeige MENU.
- 6 Tasten ◐ (Kontrast) links und rechts (←/→) (Seite 6-15, 20)**  
Zum Einstellen des Kontrasts.  
Fungieren als die Tasten (←/→) zum Einstellen weiterer Optionen.
- 7 Netzschalter und -anzeige ⏻ (Seite 16, 20)**  
Zum Ein- und Ausschalten des Monitors.  
Die Netzanzeige leuchtet grün, wenn der Monitor eingeschaltet ist, und blinkt grün und orange bzw. leuchtet orange, wenn sich der Monitor im Energiesparmodus befindet.

## Rückseite

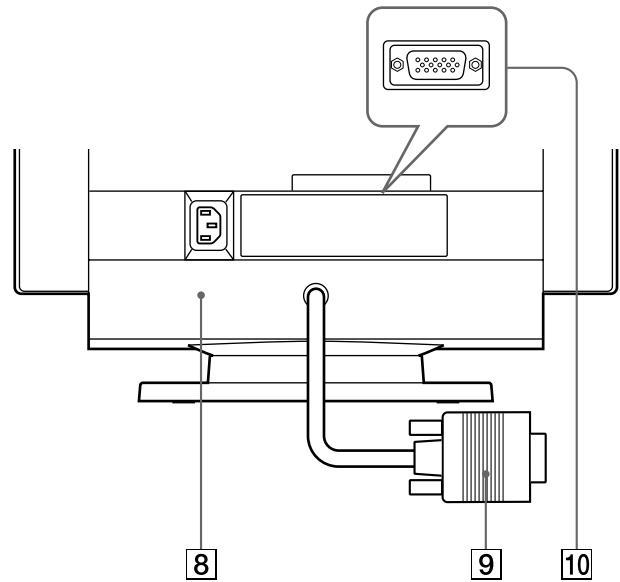

- 8 Netzeingang AC IN (Seite 4)**  
Zur Stromversorgung des Monitors.
- 9 Videoeingang 1 (HD15) (Seite 4)**  
Zum Einspeisen von RGB-Videosignalen (0,700 Vp-p, positiv) und SYNC-Signalen.

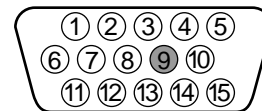

Stift Nr.	Signal	Stift Nr.	Signal
1	Rot	8	Masse Blau
2	Grün (Grünsignal mit Synchronisation)	9	—
		10	Masse
3	Blau	11	ID (Masse)
		12	Bidirektionale Daten (SDA)*
4	ID (Masse)	13	H. Sync
5	DDC-Masse*	14	V. Sync
6	Masse Rot	15	Datentakt (SCL)*
7	Masse Grün		

\* DDC-Standard (DDC = Display Data Channel) nach VESA

- 10 Videoeingang 2 (HD15) (Seite 4)**  
Zum Einspeisen von RGB-Videosignalen (0,700 Vp-p, positiv) und SYNC-Signalen, Synchronisationssignalen.  
In der Tabelle oben ist die Stiftbelegung angegeben.

D

### Anschließen des Geräts

Dieser Monitor kann mit Plattformen eingesetzt werden, die mit einer Horizontalfrequenz zwischen 30 und 107 kHz arbeiten.

#### Schritt 1: Stellen Sie sicher, daß Computer und Monitor ausgeschaltet sind

#### Schritt 2: Schließen Sie den Monitor an den Computer an

Schließen Sie das Videosignalkabel an den Videoausgang des Computers an.

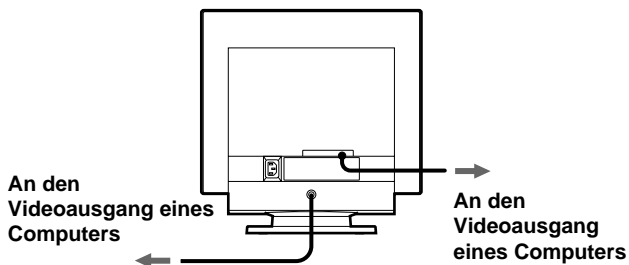

#### Hinweis

Schließen Sie die Stifte des Videosignalkabels nicht kurz.

#### Schritt 3: Schließen Sie das Netzkabel an

Schließen Sie bei ausgeschaltetem Monitor ein geeignetes Netzkabel an den Monitor und die Netzsteckdose an.

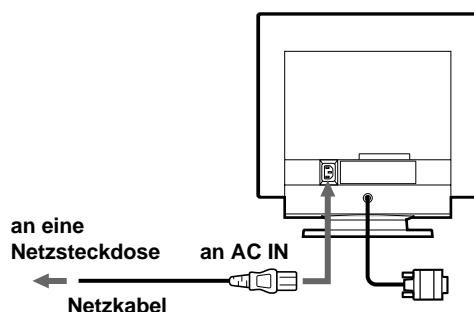

#### Schritt 4: Schalten Sie Monitor und Computer ein

#### Schritt 5: Stellen Sie gegebenenfalls den Monitor mit den Bedienelementen nach Ihren Wünschen ein

Die Installation des Monitors ist damit abgeschlossen.

#### Hinweis

Wenn auf dem Bildschirm kein Bild und statt dessen nur die Meldung „NICHT IM ABTASTBEREICH“ oder „MONITOR IST IM ENERGIESPARMODUS“ erscheint, schlagen Sie bitte unter „Warmmeldungen“ auf Seite 17 nach.

#### Vorbereiten des Arbeitsplatzes

##### Auswählen des Aufstellorts für den Monitor

Wählen Sie eine geeignete Stelle für den Monitor aus: Er sollte sich nicht in der Nähe einer fluoreszierenden Deckenbeleuchtung oder in der Nähe eines Geräts befinden, das ein Magnetfeld erzeugt, denn dieses könnte zu Interferenzen mit dem Monitor führen. Achten Sie darauf, daß das Möbelstück oder Montageteil, auf das Sie den Monitor stellen, dessen Gewicht tragen kann. Lassen Sie zur Belüftung um den Monitor mindestens 5 cm Platz frei.

##### Höhe

Stellen Sie den Monitor so auf, daß sich die obere Kante des Bildschirms etwas unterhalb Ihrer Augenhöhe befindet, wenn Sie am Arbeitsplatz sitzen.

##### Ausrichtung

Richten Sie den Monitor so aus, daß möglichst wenig Reflexionen durch Lampen oder Fenster auftreten. In der Regel empfiehlt es sich, einen Monitor im rechten Winkel zu den Fenstern aufzustellen. Der Monitor sollte möglichst direkt vor Ihnen stehen, so daß Sie nicht in gedrehter Haltung arbeiten müssen. Neigen Sie den Monitor so, daß Sie die Bildschirmanzeige bequem erkennen können.

#### Arbeitsweise

##### Pausen

Machen Sie regelmäßig Pausen. Verändern Sie gelegentlich Ihre Sitzhaltung, stehen Sie auf, und strecken Sie sich. Andernfalls kann die Arbeit am Computer auf die Dauer ermüdend wirken.

##### Rücken

Setzen Sie sich auf dem Stuhl weit nach hinten, und benutzen Sie die Rückenlehne.

##### Hände

Schlagen Sie die Tasten der Tastatur nur leicht an, und achten Sie darauf, Hände und Finger dabei entspannt zu halten. Lassen Sie einen gewissen Abstand zwischen der Vorderkante der Tastatur und der Schreibtischkante, so daß Sie die Handgelenke in Schreibpausen abstützen können. Mitunter empfiehlt sich die Verwendung einer Handgelenkstütze.

##### Augen

Genau wie jede andere Arbeit, die konzentriertes Schauen auf kurze Entfernungen über einen längeren Zeitraum erfordert, kann die Arbeit am Bildschirm die Augen belasten. Schauen Sie öfter einmal vom Bildschirm weg, und lassen Sie Ihre Sehkraft regelmäßig untersuchen.

##### Bildschirmeinstellungen

Stellen Sie Helligkeit und Kontrast am Bildschirm auf einen Wert ein, den Sie als angenehm empfinden. Im Lauf des Tages muß die Helligkeitseinstellung unter Umständen auch einmal geändert werden. In vielen Anwendungen können Sie darüber hinaus die Farbkombination so einstellen, wie es Ihnen angenehm ist.



## Auswählen des Eingangssignals

Über den Videoeingang 1 und den Videoeingang 2 können Sie zwei Computer an diesen Monitor anschließen. Mit dem Schalter INPUT 1-2 schalten Sie zwischen den beiden Computern um.

Verschieben Sie den Schalter INPUT 1-2.

Der ausgewählte Anschluß wird 3 Sekunden lang auf dem Bildschirm angezeigt.



„EINGANG 1“ (Videoeingang 1) oder „EINGANG 2“ (Videoeingang 2) wird auf dem Bildschirm angezeigt.

### Hinweis

Wenn am ausgewählten Eingang kein Signal eingespeist wird, erscheint KEIN EINGANGSSIGNAL auf dem Bildschirm. Nach einigen Sekunden schaltet der Monitor in den Energiesparmodus. Schalten Sie in diesem Fall zum anderen Eingang um.

## Automatisches Einstellen der Größe und Zentrierung des Bildes

Sie können Größe und Zentrierung des Bildes mit der Taste  (Größe/Zentrierung automatisch einstellen) problemlos so einstellen, daß das Bild den Bildschirm ausfüllt.

Drücken Sie die Taste .

Das Bild wird automatisch so eingestellt, daß es den Bildschirm ausfüllt.

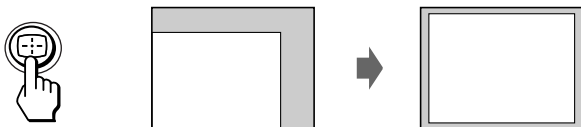

### Hinweise

- Diese Funktion ist speziell für Computer konzipiert, bei denen das Bild den ganzen Bildschirm ausfüllt. Sie arbeitet möglicherweise nicht korrekt, wenn die Hintergrundfarbe dunkel ist oder das eingespeiste Bild den Bildschirm nicht ganz ausfüllt.
- Bilder mit einem Bildseitenverhältnis von 5:4 (Auflösung: 1280 × 1024) werden mit ihrer tatsächlichen Auflösung angezeigt und füllen den Bildschirm nicht bis zu den Rändern aus.
- Das angezeigte Bild bewegt sich einige Sekunden lang, wenn Sie die Taste  drücken. Dies ist keine Fehlfunktion.

## Vorbereitungen



- Verbinden Sie den Monitor mit dem Computer, und schalten Sie beide Geräte ein.

## Auswählen der Sprache für die Bildschirmanzeigen

Wenn Sie die Sprache für die Bildschirmanzeigen ändern wollen, schlagen Sie unter „Die Bildschirmanzeige LANGUAGE “ auf Seite 11 nach. Die Standardeinstellung ist „English“.

## Einstellen von Bildhelligkeit und Kontrast

Der Wert, den Sie hier einstellen, wird für alle eingespeisten Eingangssignale gespeichert.

- 1 Drücken Sie die Tasten  (Helligkeit)  $\downarrow/\uparrow$  oder  (Kontrast)  $\leftarrow/\rightarrow$ . Die Bildschirmanzeige HELLGKEIT/KONTRAST erscheint.

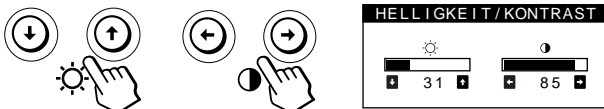

- 2 Zum Einstellen der Helligkeit Drücken Sie die Tasten  $\downarrow/\uparrow$ .

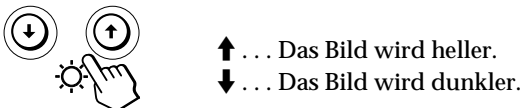

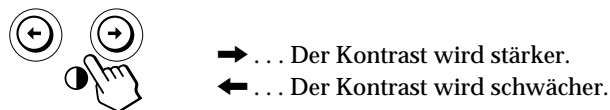

- Zum Einstellen des Kontrasts Drücken Sie die Tasten  $\leftarrow/\rightarrow$ .



Die Bildschirmanzeige wird nach etwa 3 Sekunden automatisch ausgeblendet.

Drücken Sie zum Zurücksetzen des Wertes die Taste  $\rightarrow$  (Zurücksetzen), bevor die Bildschirmanzeige ausgeblendet wird. Helligkeit und Kontrast werden damit auf die werkseitigen Einstellungen zurückgesetzt.

Wenn Sie sRGB als Farbeinstellung auf „EIN“ setzen, werden die Werte für Helligkeit () und Kontrast () automatisch auf „31“ bzw. „85“ festgelegt.

Weitere Informationen zum sRGB-Modus finden Sie unter „Die Bildschirmanzeige FARBE “ auf Seite 9.

## Das Bildschirmmenüsystem





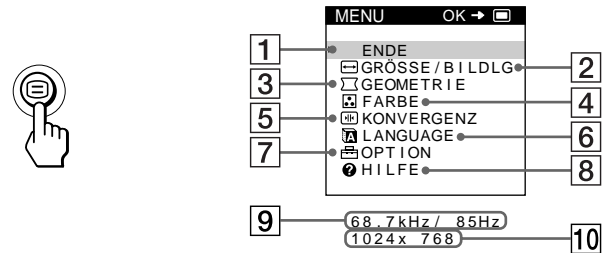

Die meisten Einstellungen nehmen Sie über die Bildschirmanzeige MENU vor.

### Bildschirmanzeige MENU

Rufen Sie mit der Taste  die Bildschirmanzeige MENU (das Menü) auf.

Die Bildschirmanzeige MENU enthält Links zu den anderen Bildschirmanzeigen, die im folgenden beschrieben werden.



- 1 **ENDE**  
Zum Schließen der Bildschirmanzeige MENU.
- 2  **GRÖSSE/BILDLG**  
Im Menü GRÖSSE/BILDLG können Sie Größe, Position und Zoom des Bildes einstellen.
- 3  **GEOMETRIE**  
Zum Aufrufen der Bildschirmanzeige GEOMETRIE, mit der Sie die Bildrotation und Kissenverzeichnung usw. korrigieren können.
- 4  **FARBE**  
Zum Aufrufen der Bildschirmanzeige FARBE, mit der Sie die Farbtemperatur einstellen können.
- 5  **KONVERGENZ**  
Im Menü KONVERGENZ können Sie die horizontale und vertikale Konvergenz des Bildes einstellen.
- 6  **LANGUAGE**  
Zum Aufrufen der Bildschirmanzeige LANGUAGE, mit der Sie die Sprache auswählen können.
- 7  **OPTION**  
Zum Aufrufen der Bildschirmanzeige OPTION, mit der Sie die Position der Bildschirmanzeigen einstellen und den Bildschirm entmagnetisieren können usw.
- 8  **HILFE**  
Rufen Sie das Menü HILFE auf, um nützliche Tips und Informationen zu diesem Monitor anzeigen zu lassen.
- 9 **Horizontal- und Vertikalfrequenz des aktuellen Eingangssignals**  
Hier werden die Horizontal- und die Vertikalfrequenz des aktuellen Eingangssignals angezeigt.
- 10 **Auflösung des aktuellen Eingangssignals**  
Wenn das Signal einem der werkseitig voreingestellten Modi des Monitors entspricht, wird auch die Auflösung angezeigt.



## Die Bildschirmanzeige GRÖSSE/ BILDLG

Im Menü GRÖSSE/BILDLG können Sie Größe, Position und Zoom des Bildes einstellen.

Der Wert, den Sie hier einstellen, wird nur für das gerade eingespeiste Eingangssignal gespeichert.

- 1 Drücken Sie die Taste .  
Die Bildschirmanzeige MENU erscheint.





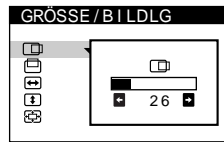
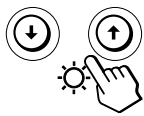

- 2 Wählen Sie mit den Tasten  $\downarrow/\uparrow$  die Option „ GRÖSSE/BILDLG“ aus, und drücken Sie die Taste  erneut.  
Die Bildschirmanzeige GRÖSSE/BILDLG erscheint.

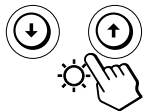







- 3 Wählen Sie mit den Tasten  $\downarrow/\uparrow$  die einzustellende Option aus.

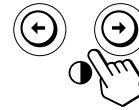

Option	Funktion
 (horizontale Zentrierung)	Einstellen der horizontalen Zentrierung des Bildes
 (vertikale Zentrierung)	Einstellen der vertikalen Zentrierung des Bildes
 (Bildbreite)	Einstellen der Bildbreite (horizontale Bildgröße)
 (Bildhöhe)	Einstellen der Bildhöhe (vertikale Bildgröße)
 (Zoom)	Vergrößern oder Verkleinern des Bildes

- 4 Stellen Sie mit den Tasten  $\leftarrow/\rightarrow$  die Option ein.



Option	Funktion
 (horizontale Zentrierung)	$\rightarrow$ ... Das Bild wird nach rechts verschoben $\leftarrow$ ... Das Bild wird nach links verschoben
 (vertikale Zentrierung)	$\rightarrow$ ... Das Bild wird nach oben verschoben $\leftarrow$ ... Das Bild wird nach unten verschoben
 (Bildbreite)	$\rightarrow$ ... Das Bild wird breiter $\leftarrow$ ... Das Bild wird schmaler
 (Bildhöhe)	$\rightarrow$ ... Das Bild wird höher $\leftarrow$ ... Das Bild wird niedriger
 (Zoom)	$\rightarrow$ ... Das Bild wird vergrößert $\leftarrow$ ... Das Bild wird verkleinert

Drücken Sie einmal die Taste , um zur Bildschirmanzeige MENU zu wechseln. Wenn Sie zur normalen Anzeige wechseln wollen, drücken Sie die Taste zweimal. Wenn Sie keine weitere Taste drücken, wird das Bildschirmmenü nach etwa 30 Sekunden automatisch ausgeblendet.

Drücken Sie zum Zurücksetzen des Wertes die Taste  $\rightarrow\leftarrow$  (Zurücksetzen), bevor die Bildschirmanzeige ausgeblendet wird.

Die ausgewählte Option wird auf die werkseitige Einstellung zurückgesetzt.

### Hinweis

Sobald die maximale bzw. minimale Höhe bzw. Breite des Bildes erreicht ist, läßt sich die Option  (Zoom) nicht weiter ändern. Der horizontale Einstellwert wird nicht im Menü angezeigt.



## Die Bildschirmanzeige GEOMETRIE

Mit der Bildschirmanzeige GEOMETRIE können Sie Form und Ausrichtung des Bildes festlegen.

Der Wert für die Option  (Bildrotation), den Sie hier einstellen, wird für alle eingespeisten Eingangssignale gespeichert. Alle anderen Einstellungen werden nur für das gerade eingespeiste Eingangssignal gespeichert.

- 1 Drücken Sie die Taste .  
Die Bildschirmanzeige MENU erscheint.





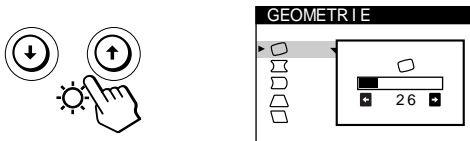

- 2 Wählen Sie mit den Tasten  $\downarrow/\uparrow$  die Option „ GEOMETRIE“ aus, und drücken Sie die Taste  erneut.  
Die Bildschirmanzeige GEOMETRIE erscheint.

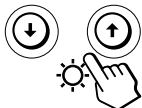









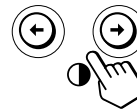







- 3 Wählen Sie mit den Tasten  $\downarrow/\uparrow$  die einzustellende Option aus.



Option	Funktion
 (Bildrotation)	Korrigieren der Bildrotation
 (Kissenverzeichnung)	Einstellen der Bildränder
 (Seitenkorrektur)	Einstellen der Balance der Bildränder
 (Trapezverzerrung)	Einstellen der Bildbreite
 (Winkelkorrektur)	Einstellen der Balance der Bildform

- 4 Stellen Sie mit den Tasten  $\leftarrow/\rightarrow$  die Option ein.



Einzustellende Option	Taste
 (Bildrotation)	<p><math>\rightarrow</math> ... Das Bild wird im Uhrzeigersinn gedreht</p>  <p><math>\leftarrow</math> ... Das Bild wird gegen den Uhrzeigersinn gedreht</p> 
 (Kissenverzeichnung)	<p><math>\rightarrow</math> ... Das Bild wird an den Seiten nach außen gewölbt</p>  <p><math>\leftarrow</math> ... Das Bild wird an den Seiten nach innen gewölbt</p> 
 (Seitenkorrektur)	<p><math>\rightarrow</math> ... Das Bildseiten werden nach rechts gewölbt</p>  <p><math>\leftarrow</math> ... Das Bildseiten werden nach links gewölbt</p> 
 (Trapezverzerrung)	<p><math>\rightarrow</math> ... Der obere Rand des Bildes wird verlängert</p>  <p><math>\leftarrow</math> ... Der obere Rand des Bildes wird verkürzt</p> 
 (Winkelkorrektur)	<p><math>\rightarrow</math> ... Der obere Rand des Bildes wird nach rechts verschoben</p>  <p><math>\leftarrow</math> ... Der obere Rand des Bildes wird nach links verschoben</p> 

Drücken Sie einmal die Taste , um zur Bildschirmanzeige MENU zu wechseln. Wenn Sie zur normalen Anzeige wechseln wollen, drücken Sie die Taste zweimal. Wenn Sie keine weitere Taste drücken, wird das Bildschirmmenü nach etwa 30 Sekunden automatisch ausgeblendet.

Drücken Sie zum Zurücksetzen des Wertes die Taste  $\rightarrow\rightarrow\rightarrow$  (Zurücksetzen), bevor die Bildschirmanzeige ausgeblendet wird. Die ausgewählte Option wird auf die werkseitige Einstellung zurückgesetzt.





## Die Bildschirmanzeige FARBE

Sie können die Farbtemperatur des Monitors ändern. So lassen sich zum Beispiel die Farben eines Bildes auf dem Bildschirm präzise auf die Farben eines gedruckten Bildes abstimmen.



Der Wert, den Sie hier einstellen, wird für alle eingespeisten Eingangssignale gespeichert.

- 1 Drücken Sie die Taste .  
Die Bildschirmanzeige MENU erscheint.

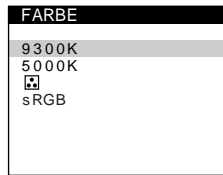
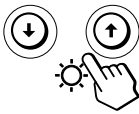

- 2 Wählen Sie mit den Tasten / die Option „ FARBE“ aus, und drücken Sie die Taste  erneut.  
Die Bildschirmanzeige FARBE erscheint.





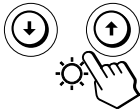

- 3 Wählen Sie mit den Tasten / die Farbtemperatur aus.



In der Bildschirmanzeige stehen zwei Farbtemperaturmodi zur Verfügung.  
Der Wert 9.300 K ist voreingestellt.

Einstellen einer eigenen Farbtemperatur zwischen 9.300 K und 5.000 K

Wählen Sie mit den Tasten / die Option „ (Variabel)“ aus, und stellen Sie diese mit den Tasten / ein.

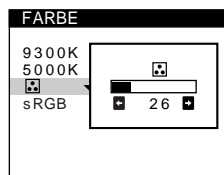
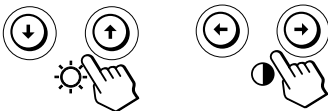

- ➔ ... Farbtemperatur wird höher (bläulich).
- ➔ ... Farbtemperatur wird niedriger (rötlich).







Drücken Sie einmal die Taste , um zur Bildschirmanzeige MENU zu wechseln. Wenn Sie zur normalen Anzeige wechseln wollen, drücken Sie die Taste zweimal. Wenn Sie keine weitere Taste drücken, wird das Bildschirmmenü nach etwa 30 Sekunden automatisch ausgeblendet.

Drücken Sie zum Zurücksetzen des Wertes die Taste  (Zurücksetzen), bevor die Bildschirmanzeige ausgeblendet wird. Die ausgewählte Farbtemperatur wird auf die werkseitigen Einstellungen zurückgesetzt.

## Der sRGB-Modus

Die sRGB-Farbeeinstellung ist ein Farbraumprotokoll nach Industriestandard, mit dem die angezeigten und die gedruckten Farben sRGB-kompatibler Computer-Produkte in Übereinstimmung gebracht werden sollen. Zum Einstellen der Farben für das sRGB-Profil setzen Sie einfach den Modus sRGB im Menü FARBE auf „EIN“.

Damit die sRGB-Farben allerdings korrekt angezeigt werden ( $\gamma=2,2$ , 6500K), müssen Sie an Ihrem Computer das sRGB-Profil einstellen.

Wenn Sie sRGB auf „EIN“ setzen, werden die Werte für Helligkeit  und Kontrast  automatisch auf „31“ bzw. „85“ festgelegt. Wenn Sie Helligkeit  und Kontrast  ändern, wechselt die Einstellung von sRGB auf „AUS“.  
Informationen zum Ändern von Helligkeit  und Kontrast  finden Sie auf Seite 6.

## Hinweis

Der Computer und sonstige angeschlossene Geräte (zum Beispiel ein Drucker) müssen sRGB-kompatibel sein.

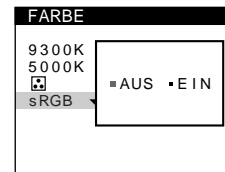





## Die Bildschirmanzeige KONVERGENZ



Mit den Optionen im Menü KONVERGENZ können Sie die Bildqualität steuern, indem Sie die Konvergenz einstellen. Die Konvergenz bezieht sich auf die Ausrichtung der Farbsignale für Rot, Grün und Blau. Wenn Buchstaben oder Linien rote oder blaue Schatten aufweisen, stellen Sie die Konvergenz ein. Der Wert, den Sie hier einstellen, wird für alle eingespeisten Eingangssignale gespeichert.

- 1 Drücken Sie die Taste .  
Die Bildschirmanzeige MENU erscheint.



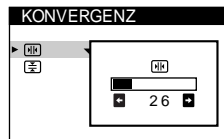
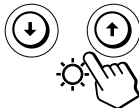

- 2 Wählen Sie mit den Tasten / die Option „ KONVERGENZ“ aus, und drücken Sie die Taste  erneut.  
Die Bildschirmanzeige KONVERGENZ erscheint.



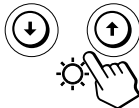



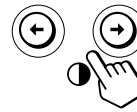

- 3 Wählen Sie mit den Tasten / die einzustellende Option aus.





- 4 Stellen Sie mit den Tasten / die Option ein.



Einzustellende Option	Taste
	 ... Die Rotkomponente wird nach rechts, die Blaukomponente nach links verschoben
(horizontale Konvergenz)	 ... Die Rotkomponente wird nach links, die Blaukomponente nach rechts verschoben
	 ... Die Rotkomponente wird nach oben, die Blaukomponente nach unten verschoben
(vertikale Konvergenz)	 ... Die Rotkomponente wird nach unten, die Blaukomponente nach oben verschoben

Drücken Sie einmal die Taste , um zur Bildschirmanzeige MENU zu wechseln. Wenn Sie zur normalen Anzeige wechseln wollen, drücken Sie die Taste zweimal. Wenn Sie keine weitere Taste drücken, wird das Bildschirmmenü nach etwa 30 Sekunden automatisch ausgeblendet.

Drücken Sie zum Zurücksetzen des Wertes die Taste  (Zurücksetzen), bevor die Bildschirmanzeige ausgeblendet wird. Die ausgewählte Option wird auf die werkseitige Einstellung zurückgesetzt.



Option	Funktion
 (horizontale Konvergenz)	Einstellen der horizontalen Konvergenz
 (vertikale Konvergenz)	Einstellen der vertikalen Konvergenz

## Die Bildschirmanzeige LANGUAGE

Für die Bildschirmmenüs stehen die Sprachen Englisch, Französisch, Deutsch, Spanisch, Italienisch, Niederländisch, Schwedisch, Russisch und Japanisch zur Verfügung.

- 1 Drücken Sie die Taste .  
Die Bildschirmanzeige MENU erscheint.



- 2 Wählen Sie mit den Tasten  $\downarrow/\uparrow$  die Option „ LANGUAGE“ aus, und drücken Sie die Taste  erneut.  
Die Bildschirmanzeige LANGUAGE erscheint.



- 3 Wählen Sie mit den Tasten  $\downarrow/\uparrow$  die gewünschte Sprache aus.



- ENGLISH: Englisch
- FRANÇAIS: Französisch
- DEUTSCH
- ESPAÑOL: Spanisch
- ITALIANO: Italienisch
- NEDERLANDS: Niederländisch
- SVENSKA: Schwedisch
- РУССКИЙ: Russisch
- 日本語: Japanisch

Drücken Sie einmal die Taste , um zur Bildschirmanzeige MENU zu wechseln. Wenn Sie zur normalen Anzeige wechseln wollen, drücken Sie die Taste zweimal. Wenn Sie keine weitere Taste drücken, wird das Bildschirmmenü nach etwa 30 Sekunden automatisch ausgeblendet.

Drücken Sie zum Zurücksetzen des Wertes auf „English“ die Taste  $\leftarrow$  (Zurücksetzen), bevor die Bildschirmanzeige ausgeblendet wird.

## Die Bildschirmanzeige OPTION



Mit der Bildschirmanzeige OPTION können Sie den Bildschirm von Hand entmagnetisieren, den Grad der Moiré-Korrektur regulieren und die Position der Bildschirmanzeigen einstellen. Außerdem können Sie die Bedienelemente sperren.

### Entmagnetisieren des Bildschirms

Der Monitorbildschirm wird automatisch entmagnetisiert, wenn das Gerät eingeschaltet wird. Sie können den Monitor aber auch von Hand entmagnetisieren.

- 1 Drücken Sie die Taste .  
Die Bildschirmanzeige MENU erscheint.



- 2 Wählen Sie mit den Tasten  $\downarrow/\uparrow$  die Option „ OPTION“ aus, und drücken Sie die Taste  erneut.  
Die Bildschirmanzeige OPTION erscheint.

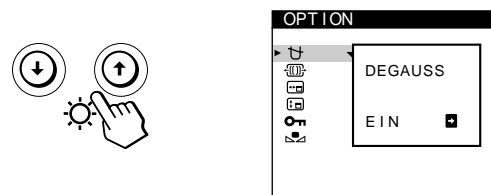

- 3 Wählen Sie mit den Tasten  $\downarrow/\uparrow$  die Option „ (DEGAUSS)“ aus.

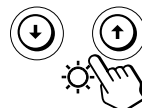

- 4 Drücken Sie die Taste  $\rightarrow$ .  
Der Bildschirm wird etwa 5 Sekunden lang entmagnetisiert.

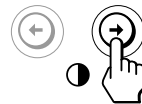

Wenn Sie den Bildschirm ein zweites Mal entmagnetisieren wollen, warten Sie mindestens 20 Minuten, bevor Sie die oben erläuterten Schritte erneut ausführen.





Drücken Sie einmal die Taste , um zur Bildschirmanzeige MENU zu wechseln. Wenn Sie zur normalen Anzeige wechseln wollen, drücken Sie die Taste zweimal. Wenn Sie keine weitere Taste drücken, wird das Bildschirmmenü nach etwa 30 Sekunden automatisch ausgeblendet.

## Korrigieren des Moiré-Effekts



Wenn elliptische oder wellenförmige Muster auf dem Bildschirm erscheinen, stellen Sie den Grad der Moiré-Korrektur ein.

- 1 Drücken Sie die Taste .  
Die Bildschirmanzeige MENU erscheint.



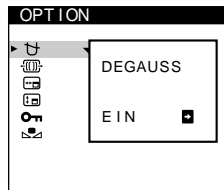
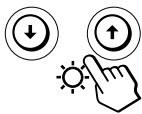

- 2 Wählen Sie mit den Tasten / die Option „ OPTION“ aus, und drücken Sie die Taste  erneut.  
Die Bildschirmanzeige OPTION erscheint.

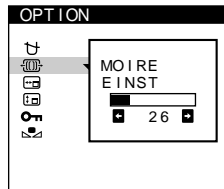
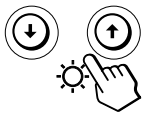

- 3 Wählen Sie mit den Tasten / die Option „ MOIRE\* EINST“ aus.



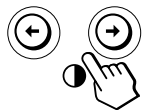

- 4 Regulieren Sie dann mit den Tasten / den Grad der Moiré-Korrektur, bis der Moiré-Effekt auf ein Minimum reduziert ist.

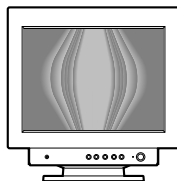

\* Moiré ist eine natürliche Interferenz, die weiche, wellenförmige Linien auf dem Bildschirm verursacht. Diese Linien können durch die Interferenz zwischen dem Muster des Bildes auf dem Bildschirm und dem Phosphor-Pitch-Muster des Monitors entstehen.

Beispiel für den Moiré-Effekt:



Drücken Sie einmal die Taste , um zur Bildschirmanzeige MENU zu wechseln. Wenn Sie zur normalen Anzeige wechseln wollen, drücken Sie die Taste zweimal. Wenn Sie keine weitere Taste drücken, wird das Bildschirmmenü nach etwa 30 Sekunden automatisch ausgeblendet.





Drücken Sie zum Zurücksetzen die Taste  (Zurücksetzen), solange das Bildschirmmenü angezeigt wird.

## Ändern der Position der Bildschirmanzeigen





Sie können die Bildschirmanzeigen verschieben, wenn Sie z. B. den Bereich hinter einer Bildschirmanzeige einstellen wollen.

- 1 Drücken Sie die Taste .  
Die Bildschirmanzeige MENU erscheint.

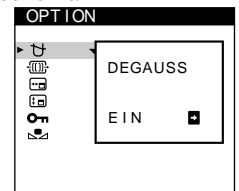
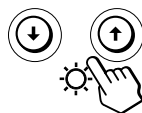

- 2 Wählen Sie mit den Tasten / die Option „ OPTION“ aus, und drücken Sie die Taste  erneut.  
Die Bildschirmanzeige OPTION erscheint.



- 3 Wählen Sie mit den Tasten / die Option „ (POSITION H OSD)“ oder „ (POSITION V OSD)“ aus.

Wählen Sie „ (POSITION H OSD)“ aus, um die Position in der Horizontalen einzustellen.

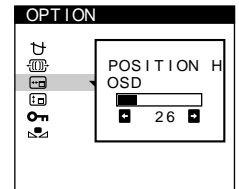
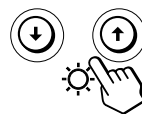

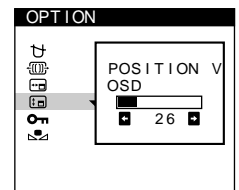
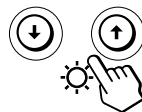

Wählen Sie „ (POSITION V OSD)“ aus, um die Position in der Vertikalen einzustellen.

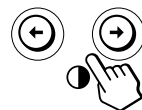

- 4 Verschieben Sie die Bildschirmanzeige mit den Tasten / zur gewünschten Position.



Drücken Sie einmal die Taste , um zur Bildschirmanzeige MENU zu wechseln. Wenn Sie zur normalen Anzeige wechseln wollen, drücken Sie die Taste zweimal. Wenn Sie keine weitere Taste drücken, wird das Bildschirmmenü nach etwa 30 Sekunden automatisch ausgeblendet.

Drücken Sie zum Zurücksetzen des Wertes die Taste  (Zurücksetzen), bevor die Bildschirmanzeige ausgeblendet wird.





## Sperrung der Bedienelemente

Sie können die Einstellungen schützen, indem Sie die Bedienelemente und Menüs sperren.

- 1 Drücken Sie die Taste .  
Die Bildschirmanzeige MENU erscheint.



- 2 Wählen Sie mit den Tasten  $\downarrow/\uparrow$  die Option „ OPTION“ aus, und drücken Sie die Taste  erneut.  
Die Bildschirmanzeige OPTION erscheint.

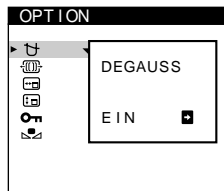
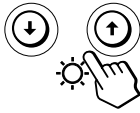



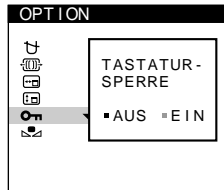
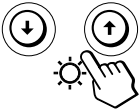

- 3 Wählen Sie mit den Tasten  $\downarrow/\uparrow$  die Option „ (TASTATURSPERRE)“ aus.

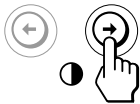

- 4 Wählen Sie mit der Taste  $\rightarrow$  die Einstellung „EIN“ aus.



Drücken Sie einmal die Taste , um zur Bildschirmanzeige MENU zu wechseln. Wenn Sie zur normalen Anzeige wechseln wollen, drücken Sie die Taste zweimal. Wenn Sie keine weitere Taste drücken, wird das Bildschirmmenü nach etwa 30 Sekunden automatisch ausgeblendet.

Jetzt können Sie nur noch den Netzschalter , die Option ENDE und die Option „ (TASTATURSPERRE)“ im Bildschirmmenü „ OPTION“ benutzen. Wenn Sie etwas anderes auswählen, erscheint die Markierung  auf dem Bildschirm.

### So heben Sie die Sperrung der Bedienelemente und Menüs wieder auf



Gehen Sie wie in Schritt 1 bis 3 oben erläutert vor, und wählen Sie mit der Taste  $\leftarrow$  die Option „AUS“.

## Wiederherstellen der Farben

Bei den meisten Bildschirmen zeigt sich nach einer Anzahl von Jahren ein allmähliches Nachlassen der Farbbrillanz. Mit der Funktion FARBWIEDERHERSTELLUNG können Sie die Bildschirmfarben auf die ursprünglichen, werkseitig eingestellten Werte zurücksetzen. In den Schritten unten wird erläutert, wie Sie die Farben des Monitors wiederherstellen.

- 1 Drücken Sie die Taste .  
Die Bildschirmanzeige MENU erscheint.



- 2 Wählen Sie mit den Tasten  $\downarrow/\uparrow$  die Option „ OPTION“ aus, und drücken Sie die Taste  erneut.  
Die Bildschirmanzeige OPTION erscheint.

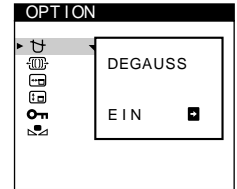
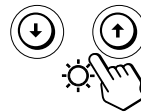

- 3 Wählen Sie mit den Tasten  $\downarrow/\uparrow$  die Option „ (FARBWIEDERHERSTELLUNG)“ aus.

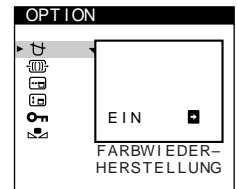
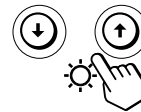

- 4 Wählen Sie mit der Taste  $\rightarrow$  die Einstellung „EIN“ aus.

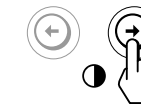

Das Bild wird ausgeblendet, während die Farben wiederhergestellt werden (etwa 2 Sekunden lang). Wenn die Farben wiederhergestellt sind, erscheint das Bild wieder auf dem Bildschirm.

Drücken Sie einmal die Taste , um zur Bildschirmanzeige MENU zu wechseln. Wenn Sie zur normalen Anzeige wechseln wollen, drücken Sie die Taste zweimal. Wenn Sie keine weitere Taste drücken, wird das Bildschirmmenü nach etwa 30 Sekunden automatisch ausgeblendet.

## Hinweise

- Bevor Sie diese Funktion verwenden können, muß sich der Monitor mindestens 30 Minuten lang im normalen Betriebsmodus befinden (Netzanzeige leuchtet grün). Wenn der Monitor in den Energiesparmodus wechselt, müssen Sie ihn wieder in den normalen Betriebsmodus schalten und 30 Minuten lang abwarten. Unter Umständen müssen Sie die Energiespareinstellungen Ihres Computers ändern, damit der Monitor die gesamten 30 Minuten im normalen Betriebsmodus bleibt. Ist der Monitor nicht bereit, erscheint eine entsprechende Nachricht.

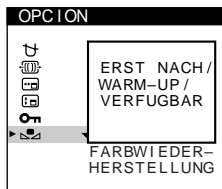





- Aufgrund des natürlichen Alterungsprozesses der Bildröhre läßt sich diese Funktion nach längerer Zeit unter Umständen nicht mehr ausführen.

## Die Bildschirmanzeige HILFE ?



Das Menü HILFE enthält nützliche Tips und Informationen zu diesem Monitor. Wenn an dem Monitor Symptome auftreten, die im Menü HILFE aufgelistet sind, können Sie das Problem anhand der Anweisungen im Menü beheben. Wenn die Symptome nicht im Menü HILFE aufgelistet sind oder wenn das Problem bestehen bleibt, schlagen Sie bitte unter „Störungsbehebung“ auf Seite 18 nach.

- 1 Drücken Sie die Taste .  
Die Bildschirmanzeige MENU erscheint.

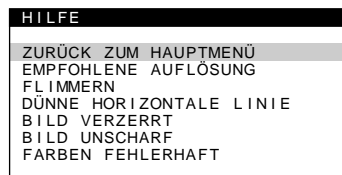
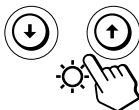

- 2 Wählen Sie mit den Tasten / die Option „ HILFE“ aus, und drücken Sie die Taste  erneut.  
Die Bildschirmanzeige „HILFE“ erscheint.



- 3 Wählen Sie mit den Tasten / eine Option im Menü HILFE aus.  
Anweisungen oder Informationen zum Beheben des Problems werden am Bildschirm angezeigt. Es folgt eine Erläuterung der einzelnen Menüoptionen.

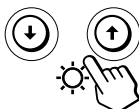

## EMPFOHLENE AUFLÖSUNG

Wenn das Bild den Bildschirm nicht ganz ausfüllt oder wenn das Bild für den Bildschirm zu groß ist, stellen Sie am Computer die Auflösung auf die im Menü angegebenen Werte ein. Entspricht das Eingangssignal einem der werkseitig vordefinierten Modi des Monitors, werden die Auflösung und die Auffrischungsrate des aktuellen Eingangssignals angezeigt.

## FLIMMERN

Wenn das Bild flimmert, stellen Sie die Auffrischungsrate auf die im Menü angegebenen Werte ein. Entspricht das Eingangssignal einem der werkseitig vordefinierten Modi des Monitors, wird die Auffrischungsrate des aktuellen Eingangssignals angezeigt.

## DÜNNE HORIZONTALE LINIE

Die Linien, die auf dem Bildschirm erscheinen, sind Dämpfungsdrähte. Weitere Informationen zu den Dämpfungsdrähten finden Sie auf Seite 16.



## BILD VERZERRT

Wenn das Bild auf dem Bildschirm nicht die korrekte Form hat, stellen Sie die Geometrie des Bildes ein. Drücken Sie die Taste , um das Menü GEOMETRIE direkt aufzurufen.

## BILD UNSCHARF

Das Bild kann verschwommen wirken, wenn die roten und blauen Farbsignale nicht korrekt ausgerichtet sind, so daß um Zeichen und Linien rote oder blaue Schatten zu sehen sind. Stellen Sie die Konvergenz des Bildes ein, so daß die Schatten verschwinden. Drücken Sie die Taste , um das Menü KONVERGENZ direkt aufzurufen. Wenn das Menü KONVERGENZ angezeigt wird, werden Kontrast, Helligkeit und Moiré-Korrektur automatisch für alle Eingangssignale zurückgesetzt.





## FARBEN FEHLERHAFT

Wenn die Farben des Bildes in einzelnen Bildbereichen nicht korrekt angezeigt werden, überprüfen Sie zuerst, ob eine Signalkabelverbindung lose ist. Wenn Sie die Kabelverbindungen überprüft haben, versuchen Sie, den Bildschirm manuell zu entmagnetisieren. Drücken Sie die Taste , um das Menü OPTION direkt aufzurufen, und wählen Sie dann  (DEGAUSS).



Drücken Sie einmal die Taste , um zur Bildschirmanzeige MENU zu wechseln. Wenn Sie zur normalen Anzeige wechseln wollen, drücken Sie die Taste zweimal. Wenn Sie keine weitere Taste drücken, wird das Bildschirmmenü nach etwa 30 Sekunden automatisch ausgeblendet.

## Zurücksetzen der Einstellungen

### Zurücksetzen einer einzelnen eingestellten Option

- 1 Wählen Sie mit den Tasten  und /  die Bildschirmanzeige mit der zurückzusetzenden Option aus, und drücken Sie nochmals die Taste .



- 2 Wählen Sie mit den Tasten /  die zurückzusetzende Option aus.

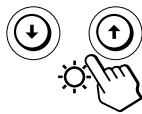

- 3 Drücken Sie die Taste  (Zurücksetzen).

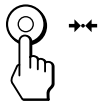

### Zurücksetzen aller Einstellungen für das aktuelle Eingangssignal

Drücken Sie die Taste  (Zurücksetzen), wenn keine Bildschirmanzeige zu sehen ist.

Alle Einstellungen für das aktuelle Eingangssignal werden auf die werkseitigen Einstellungen zurückgesetzt. Durch Zurücksetzen des aktuellen Signals ändern sich die Einstellungen für Helligkeit, Kontrast, Sprache, Position der Bildschirmanzeigen und die Tastensperrfunktion nicht.

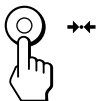



### Zurücksetzen aller Einstellungen für alle Eingangssignale

Halten Sie die Taste  (Zurücksetzen) mehr als zwei Sekunden lang gedrückt.

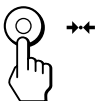
Alle Einstellungen einschließlich Helligkeit und Kontrast werden auf die werkseitigen Einstellungen zurückgesetzt.



#### Hinweis

Die Taste  (Zurücksetzen) funktioniert nicht, wenn  (TASTATURSPERRE) auf EIN gesetzt ist.

## Energiesparfunktion

Dieser Monitor entspricht den Energiesparrichtlinien der VESA und des ENERGY STAR-Programms sowie des enger gefaßten NUTEK-Standards.

Wenn der Monitor an einen Computer oder eine Grafikkarte angeschlossen ist, der bzw. die VESA DPMS unterstützt (Display Power Management Signaling) wird die Leistungsaufnahme des Geräts in drei Stufen wie unten erläutert reduziert.

### Hinweise

- Befindet sich der Computer in einem der Energiesparmodi, erscheint auf dem Bildschirm die Meldung MONITOR IST IM ENERGIESPARMODUS, wenn Sie eine der Tasten am Monitor drücken (siehe Seite 17). Nach einigen Sekunden schaltet der Monitor erneut in den Energiesparmodus. Sobald jedoch horizontale und vertikale Synchronisationssignale eingehen, schaltet der Monitor automatisch wieder in den normalen Betriebsmodus.
- Die Energiesparfunktion wird aktiviert, wenn der Computer erkennt, daß Sie die Maus oder die Tastatur eine bestimmte Zeitspanne lang nicht benutzt haben. Diese Zeitspanne können Sie selbst definieren.
- IBM empfiehlt, den Monitor am Feierabend oder auch tagsüber bei sehr langen Arbeitspausen auszuschalten.

Energie-sparstufe	Bildschirm	Horizontales Synchronisationssignal	Vertikales Synchronisationssignal	Leistungs-aufnahme	Zeit für Reaktivierung	Netzanzeige 
1 Normalbetrieb	aktiv	vorhanden	vorhanden	≤ 140 W	—	Grün
2 Bereitschaft (1. Stufe)	leer	nicht vorhanden	vorhanden	≤ 15 W	ca. 5 Sek.	Abwechselnd grün und orange
3 Unterbrechung (2. Stufe) (Schlaf)*	leer	vorhanden	nicht vorhanden	≤ 15 W	ca. 5 Sek.	Abwechselnd grün und orange
4 Deaktiviert (3. Stufe) (Tiefschlaf)*	leer	nicht vorhanden	nicht vorhanden	≤ 3 W	ca. 15 Sek.	Orange
5 Ausgeschaltet	—	—	—	≤ 0,5 W	—	Aus

\* „Schlaf“ und „Tiefschlaf“ sind Energiesparmodi, die von der EPA (Umweltschutzbehörde der USA) definiert wurden.

## Dämpfungsdrähte

Bei einem weißen Hintergrund können, wie unten abgebildet, sehr dünne, horizontale Linien auf dem Bildschirm zu sehen sein. Diese Linien sind Schatten der Dämpfungsdrähte und eine Charakteristik von Kathodenstrahlröhren mit Streifenmaske. Die Drähte befinden sich an der Streifenmaske auf der Innenseite der Trinitron-Röhre und dämpfen Vibrationen der Streifenmaske.

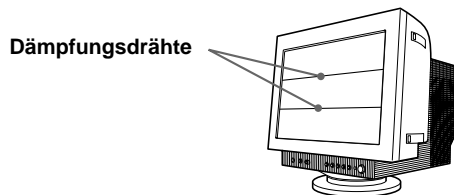

## Plug & Play

Dieser Monitor entspricht den DDC-Standards (DDC = Display Data Channel) DDC1, DDC2B und DDC2Bi der VESA.

Ist der Monitor an ein DDC1-Host-System angeschlossen, wird er gemäß dem VESA-Standard mit V.CLK synchronisiert und gibt EDID-Signale (EDID = Extended Display Identification Data) an die Datenleitung aus. Ist das Gerät an ein DDC2B- oder DDC2Bi-Hostsystem angeschlossen, schaltet es automatisch auf den entsprechenden Standard um.

### Vordefinierte Modi

Nr. (Punkte × Zeilen)	Auflösung	Horizontal- frequenz	Vertikal- frequenz	Grafikmodus
1	640 × 480	31,5 kHz	60 Hz	VGA
2	640 × 480	43,3 kHz	85 Hz	VESA
3	800 × 600	46,9 kHz	75 Hz	VESA
4	800 × 600	53,7 kHz	85 Hz	VESA
5	1024 × 768	60,0 kHz	75 Hz	VESA
6	1024 × 768	68,7 kHz	85 Hz	VESA
7	1280 × 1024	80,0 kHz	75 Hz	VESA
8	1280 × 1024	91,1 kHz	85 Hz	VESA
9	1600 × 1200	93,8 kHz	75 Hz	VESA
10	1600 × 1200	106,3 kHz	85 Hz	VESA

### Anzeigen der Monitordaten

Auf der Bildschirmanzeige INFORMATION können Sie Modellname, Seriennummer und Herstellungsjahr des Monitors anzeigen lassen.

Halten Sie die Taste  3 Sekunden lang gedrückt. Die Bildschirmanzeige INFORMATION erscheint.

Beispiel:

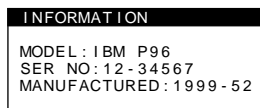

Die Bildschirmanzeige INFORMATION enthält Modellname, Seriennummer und Herstellungsjahr des Monitors.

Die Bildschirmanzeige wird nach etwa 30 Sekunden automatisch ausgeblendet.

### Warnmeldungen

Wenn auf dem Bildschirm kein Bild erscheint, wird eine der folgenden Meldungen auf dem Bildschirm angezeigt. Wie Sie das Problem beheben, schlagen Sie unter „Störungsbehebung“ auf Seite 18 nach.

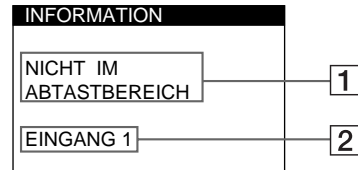

#### 1 Status des Eingangssignals

##### NICHT IM ABTASTBEREICH

Gibt an, daß das Eingangssignal nicht den technischen Daten des Monitors entspricht.

##### KEIN EINGANGSSIGNAL

Gibt an, daß kein Signal eingeht.

##### MONITOR IST IM ENERGIESPARMODUS







Gibt an, daß sich der Computer im Energiesparmodus befindet. Diese Meldung erscheint nur, wenn sich der Computer in einem der Energiesparmodi befindet und Sie eine der Tasten am Monitor drücken.

#### 2 Der ausgewählte Eingang

Diese Meldung gibt den ausgewählten Anschluß (EINGANG 1 oder EINGANG 2) an.

## Störungsbehebung

Sie können die Ursache eines Problems gegebenenfalls anhand dieses Abschnitts erkennen und beheben, ohne daß Sie sich an den Kundendienst wenden müssen.

Symptom	Überprüfen Sie bitte folgendes:
<b>Kein Bild</b>	
Die Netzanzeige  leuchtet nicht	<ul style="list-style-type: none"> <li>• Das Netzkabel muß korrekt angeschlossen sein.</li> <li>• Der Netzschalter  muß sich in der Position „EIN“ befinden.</li> </ul>
Die Meldung „KEIN EINGANGSSIGNAL“ erscheint auf dem Bildschirm, oder die Netzanzeige  leuchtet orange bzw. abwechselnd grün und orange	<ul style="list-style-type: none"> <li>• Der Netzschalter des Computers muß sich in der Position „EIN“ befinden.</li> <li>• Der Schalter INPUT 1-2 muß korrekt eingestellt sein (Seite 5).</li> <li>• Das Videosignalkabel muß korrekt angeschlossen sein, und alle Stecker müssen fest in den Buchsen sitzen.</li> <li>• Am Videoeingangsanschluß dürfen keine Stifte verbogen oder eingedrückt sein.</li> <li>• Die Grafikkarte muß korrekt im richtigen Bus-Steckplatz sitzen.</li> </ul>
Die Meldung „MONITOR IST IM ENERGIESPARMODUS“ erscheint auf dem Bildschirm, oder die Netzanzeige  leuchtet orange oder wechselt zwischen grün und orange.	<ul style="list-style-type: none"> <li>• Der Computer befindet sich im Energiesparmodus. Drücken Sie eine beliebige Taste auf der Computer-Tastatur, oder bewegen Sie die Maus.</li> <li>• Der Netzschalter des Computers muß sich in der Position „EIN“ befinden.</li> <li>• Die Grafikkarte muß korrekt im richtigen Bus-Steckplatz sitzen.</li> </ul>
Die Meldung „NICHT IM ABTASTBEREICH“ erscheint auf dem Bildschirm	<ul style="list-style-type: none"> <li>• Die Videofrequenz muß im für den Monitor angegebenen Bereich liegen. (Horizontal: 30 – 107 kHz, Vertikal: 48 – 120 Hz) Schlagen Sie in der Bedienungsanleitung zum Computer nach, und stellen Sie den Videofrequenzbereich ein.</li> <li>• Wenn Sie einen Videosignalkabeladapter verwenden, überprüfen Sie, ob Sie den richtigen Adapter angeschlossen haben.</li> </ul>
Es wird keine Meldung angezeigt, und die Netzanzeige  leuchtet grün oder blinkt orange	<ul style="list-style-type: none"> <li>• Siehe „Selbstdiagnosefunktion“ (Seite 20).</li> </ul>
<b>Das Bild ist gestört</b>	<ul style="list-style-type: none"> <li>• Schlagen Sie in der Anleitung zur Videokarte die korrekte Monitoreinstellung nach.</li> <li>• Lesen Sie in dieser Anleitung nach, ob der Grafikkmodus und die Frequenz, mit der der Monitor arbeitet, unterstützt werden. Auch wenn die Frequenz innerhalb des unterstützten Bereichs liegt, arbeiten einige Grafikkarten möglicherweise mit einem Synchronisationsimpuls, der für eine korrekte Synchronisation des Monitors zu kurz ist.</li> </ul>
<b>Die Farbe ist nicht gleichmäßig</b>	<ul style="list-style-type: none"> <li>• Entmagnetisieren Sie den Monitor (Seite 11). Wenn Sie ein Gerät, das ein Magnetfeld erzeugt (z. B. einen Lautsprecher), in der Nähe des Monitors aufstellen oder wenn Sie die Richtung des Monitors ändern, sind die Farben möglicherweise nicht mehr gleichmäßig. Mit der Entmagnetisierungsfunktion wird das Metallgehäuse der Kathodenstrahlröhre entmagnetisiert, so daß ein neutrales Feld entsteht, in dem eine gleichmäßige Farbwiedergabe möglich ist. Ist ein zweiter Entmagnetisierungszyklus erforderlich, warten Sie nach dem ersten Zyklus mindestens 20 Minuten. Auf diese Weise erreichen Sie die besten Ergebnisse.</li> </ul>
<b>Der Monitor läßt sich mit den Bedienelementen an der Vorderseite nicht einstellen</b> (  erscheint auf dem Bildschirm.)	<ul style="list-style-type: none"> <li>• Wenn die Sperrfunktion eingeschaltet ist (EIN), setzen Sie sie über das Menü OPTION auf AUS (Seite 13).</li> </ul>
<b>Weiß sieht nicht weiß aus</b>	<ul style="list-style-type: none"> <li>• Stellen Sie die Farbtemperatur ein (Seite 9).</li> </ul>

Symptom	Überprüfen Sie bitte folgendes:
Die Bildschirmanzeige ist nicht zentriert, oder die Bildgröße ist nicht korrekt	<ul style="list-style-type: none"> <li>• Drücken Sie die Taste  (Seite 5).</li> <li>• Stellen Sie die die Bildgröße bzw. Zentrierung ein (Seite 7). Bei bestimmten Videomodi füllt die Anzeige nicht den gesamten Bildschirm. Dieses Problem tritt besonders bei bestimmten Grafikkarten auf.</li> </ul>
Die Bildränder sind gekrümmt	<ul style="list-style-type: none"> <li>• Stellen Sie die Geometrie ein (Seite 8).</li> </ul>
An den Rändern weißer Linien sind rote oder blaue Schatten zu sehen	<ul style="list-style-type: none"> <li>• Stellen Sie die Konvergenz ein (Seite 10).</li> </ul>
Das Bild ist verschwommen	<ul style="list-style-type: none"> <li>• Stellen Sie Kontrast und Helligkeit ein (Seite 6).</li> <li>• Entmagnetisieren Sie den Monitor (Seite 11). Wenn Sie ein Gerät, das ein Magnetfeld erzeugt (z. B. einen Lautsprecher), in der Nähe des Monitors aufstellen oder wenn Sie die Richtung des Monitors ändern, sind die Farben möglicherweise nicht mehr gleichmäßig. Mit der Entmagnetisierungsfunktion wird das Metallgehäuse der Kathodenstrahlröhre entmagnetisiert, so daß ein neutrales Feld entsteht, in dem eine gleichmäßige Farbwiedergabe möglich ist. Ist ein zweiter Entmagnetisierungszyklus erforderlich, warten Sie nach dem ersten Zyklus mindestens 20 Minuten. Auf diese Weise erreichen Sie die besten Ergebnisse.</li> <li>• Erscheinen entlang der Bildränder rote oder blaue Schatten, stellen Sie die Konvergenz ein (Seite 10).</li> <li>• Wählen Sie MOIRE-KORREKTUR, und stellen Sie die Moiré-Korrektur ein (Seite 12).</li> </ul>
Das Bild springt oder oszilliert	<ul style="list-style-type: none"> <li>• Stellen Sie potentielle Quellen elektrischer oder magnetischer Felder, die Interferenzen mit dem Monitor verursachen können, weiter vom Monitor entfernt auf, oder entfernen Sie sie ganz. Typischerweise werden solche Störungen durch Geräte wie Ventilatoren, Leuchtstoffröhren und Laser-Drucker verursacht.</li> <li>• Steht sehr nahe bei diesem Gerät ein zweiter Monitor, vergrößern Sie den Abstand zwischen beiden Geräten, um die Interferenzen zu verringern.</li> <li>• Schließen Sie das Netzkabel des Monitors an eine andere Steckdose, möglichst an einem anderen Stromkreis, an.</li> <li>• Testen Sie den Monitor an einem anderen Computer in einem anderen Raum.</li> </ul>
Das Bild flimmert	<ul style="list-style-type: none"> <li>• Schlagen Sie in der Dokumentation zum Computer nach, und setzen Sie die Bildwiederholrate am Computer auf den Wert, mit dem Sie die besten Bilder erzielen.</li> </ul>
Doppelbilder sind zu sehen	<ul style="list-style-type: none"> <li>• Verwenden Sie keine Videoverlängerungskabel und/oder Videoschaltboxen, wenn dieses Symptom auftritt. Zu lange Kabel oder eine störanfällige Verbindung können dieses Problem auslösen.</li> </ul>
Wellenförmige oder elliptische Moiré-Effekte sind sichtbar	<ul style="list-style-type: none"> <li>• Wählen Sie MOIRE-KORREKTUR, und stellen Sie die Moiré-Korrektur ein (Seite 12). Der Moiré-Effekt muß je nach angeschlossenem Computer behoben werden.</li> <li>• Wählen Sie ein anderes Muster für Ihren Desktop. Wegen der Zusammenwirkung von Auflösung, Bildpunktdichte des Monitors und Bildpunktdichte einiger Bildmuster kann es bei einigen Hintergrundeinstellungen zu einem Moiré-Effekt kommen.</li> </ul>
Zwei dünne horizontale Linien (Drähte) sind sichtbar	<ul style="list-style-type: none"> <li>• Bei diesen Linien handelt es sich um Dämpfungsdrähte zur Stabilisierung der vertikalen Streifenmaske (Seite 16). Aufgrund dieser Streifenmaske gelangt mehr Licht auf den Bildschirm, so daß Farben und Helligkeit bei der Trinitron-Kathodenstrahlröhre intensiver sind.</li> </ul>
Die Funktion FARBWIEDERHERSTELLUNG funktioniert nicht	<ul style="list-style-type: none"> <li>• Bevor Sie diese Funktion verwenden können, muß sich der Monitor mindestens 30 Minuten lang im normalen Betriebsmodus befinden (Netzanzeige leuchtet grün). Weitere Informationen zur Funktion FARBWIEDERHERSTELLUNG finden Sie auf Seite 13.</li> <li>• Ändern Sie die Energiespareinstellungen Ihres Computers, damit der Monitor länger als 30 Minuten im normalen Betriebsmodus bleibt.</li> <li>• Aufgrund des natürlichen Alterungsprozesses der Bildröhre läßt sich diese Funktion nach längerer Zeit unter Umständen nicht mehr ausführen.</li> </ul>

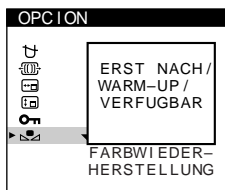

Symptom	Überprüfen Sie bitte folgendes:
Unmittelbar nach dem Einschalten ist ein Summgeräusch zu hören	<ul style="list-style-type: none"> <li>Wenn Sie den Monitor einschalten, wird der Entmagnetisierungszyklus aktiviert. Ein Summgeräusch ist zu hören, während der automatische Entmagnetisierungszyklus aktiviert ist. Dasselbe Geräusch ist bei der manuellen Entmagnetisierung zu hören. Dies ist keine Fehlfunktion.</li> </ul>



- Bleibt das Problem bestehen, wenden Sie sich bitte an das IBM HelpCenter.  
Telefonnummer in den USA: 1-800-772-2227  
Telefonnummer in Kanada: 1-800-565-3344
- Notieren Sie sich den Modellnamen und die Seriennummer Ihres Monitors. Notieren Sie sich außerdem Fabrikat und Modell Ihres Computers und der Grafikkarte.

## Selbstdiagnosefunktion

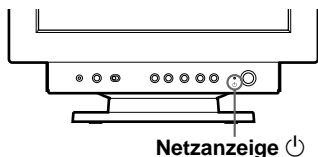
Dieser Monitor verfügt über eine Selbstdiagnosefunktion. Wenn an dem Monitor oder Computer ein Problem auftritt, erscheint ein leerer Bildschirm, und die Netzanzeige  leuchtet grün auf oder blinkt orange.



### Wenn die Netzanzeige grün leuchtet

- Lösen Sie das Videoeingangskabel, oder schalten Sie den angeschlossenen Computer aus.
- Schalten Sie den Monitor am Netzschalter  aus und dann wieder ein.
- Halten Sie die Taste  2 Sekunden lang gedrückt, bevor der Monitor in den Energiesparmodus wechselt.





Wenn alle vier Farbbalken (weiß, rot, grün, blau) angezeigt werden, funktioniert der Monitor ordnungsgemäß. Schließen Sie das Videoeingangskabel wieder an, und überprüfen Sie den Zustand Ihres Computers.

Wenn die Farbbalken nicht erscheinen, liegt möglicherweise ein Fehler am Monitor vor. Wenden Sie sich mit einer Beschreibung des Problems an das IBM HelpCenter.

### Wenn die Netzanzeige orange blinkt

Schalten Sie den Monitor am Netzschalter  aus und dann wieder ein.

Wenn die Netzanzeige  jetzt grün leuchtet, funktioniert der Monitor ordnungsgemäß.

Wenn die Netzanzeige  immer noch blinkt, liegt möglicherweise ein Fehler am Monitor vor. Wenden Sie sich mit einer Beschreibung des Problems an das IBM HelpCenter. Notieren Sie sich unbedingt die Modellbezeichnung und die Seriennummer des Monitors. Notieren Sie sich außerdem das Fabrikat und Modell Ihres Computers und der Videokarte.

## Technische Daten

Bildröhre	Streifenabstand 0,24 mm Bildschirmdiagonale 19 Zoll Ablenkung 90 Grad
Effektive Bildgröße	ca. 365 × 274 mm (B/H) Sichtbares Bild 18,0 Zoll
Auflösung	Horizontal: max. 1600 Punkte Vertikal: max. 1200 Zeilen
Standardanzeigegröße	ca. 352 × 264 mm (B/H)
Ablenkfrequenz*	Horizontal: 30 bis 107 kHz Vertikal: 48 bis 120 Hz 256 < Zeilen insgesamt < 2048
Betriebsspannung	100 bis 240 V Wechselstrom, 50 – 60 Hz, max. 2,0 A
Leistungsaufnahme	max. 140 W
Betriebstemperatur	10°C bis 40°C
Abmessungen	ca. 462 × 462 × 474 mm (B/H/T)
Gewicht	ca. 27 kg

- \* Empfohlene Werte für das horizontale und vertikale Timing
- Das horizontale Synchronbreitenverhältnis sollte über 1,0 µSek. liegen.
  - Die horizontale Austastbreite sollte über 3,0 µSek. liegen.
  - Die vertikale Austastbreite sollte über 450 µSek. liegen.

Änderungen, die dem technischen Fortschritt dienen, bleiben vorbehalten.



**Español**

# Edición 1

Esta publicación podría contener imprecisiones técnicas o errores tipográficos. La información aquí contenida será objeto de cambios periódicos, que aparecerán en ediciones posteriores. IBM podría realizar mejoras y/o cambios al producto y/o programa en cualquier momento.

Asimismo, es posible que esta publicación contenga referencias a, o información sobre, productos (máquinas y programas), programación o servicios IBM que no se anuncien en su país.

Las solicitudes de copias de esta publicación, así como de información técnica sobre productos IBM, deberían realizarse a través de su minorista IBM o su distribuidor autorizado IBM.

Queda terminantemente prohibida la reproducción o distribución de esta copia en cualquier forma o por cualquier medio sin previo permiso por escrito de la International Business Machines Corporation.

Las referencias a productos, programas o servicios IBM contenidas en esta publicación no implican que IBM pretenda poner estos productos a la venta en todos los países en los que opera. Las referencias a productos, programas o servicios IBM realizadas en este documento no implican que sean éstos los únicos que pueden utilizarse. De este modo, cualquier producto, programa o servicio funcionalmente equivalente y que no infrinja los derechos sobre la propiedad intelectual de IBM u otros derechos protegidos legalmente puede utilizarse en lugar del producto, programa o servicio IBM. La evaluación y verificación del funcionamiento de este monitor con otros productos, programas o servicios, con la excepción de aquellos expresamente designados por IBM, son responsabilidad del usuario.

IBM cuenta con patentes o proyectos de patentes que cubren los asuntos abordados en este documento. Cabe reseñar, por último, que la provisión de este documento no otorga ninguna licencia para estas patentes.

## Marcas comerciales

Las marcas comerciales que aparecen en esta publicación son marcas comerciales o marcas de servicio de IBM Corporation en Estados Unidos u otros países:

### **IBM VGA HelpCenter**

- ENERGY STAR es una marca registrada de EE.UU.
- Trinitron es una marca comercial registrada de Sony Corporation.
- DDC™ es una marca comercial de Video Electronics Standard Association.
- VESA es una marca comercial de Video Electronics Standard Association.
- El resto de los productos mencionados en este manual pueden ser marcas comerciales o marcas comerciales registradas de sus respectivas compañías.
- Además, “™” y “®” no se mencionan en cada caso en este manual.

© Copyright International Business Machines Corporation 1999.  
Todos los derechos reservados.

# INDICE







---

## Procedimientos iniciales

Precauciones .....	2
Identificación de los componentes y los controles .....	3
Instalación .....	4
Selección de la señal de entrada .....	5
Tamaño y centrado automáticos de la imagen .....	5

---

## Personalización del monitor

Selección del idioma de la indicación en pantalla .....	6
Ajuste del brillo y contraste de la imagen .....	6
Introducción al sistema de indicación en pantalla .....	6
Uso de la indicación en pantalla TAMAÑO/CENTRO  .....	7
Uso de la indicación en pantalla GEOMETRIA  .....	8
Uso de la indicación en pantalla COLOR  .....	9
Uso de la indicación en pantalla CONVERGENCIA  .....	10
Uso de la indicación en pantalla LANGUAGE  .....	11
Uso de la indicación en pantalla OPCION  .....	11
Uso de la indicación en pantalla AYUDA  .....	14
Restauración de los ajustes de fábrica .....	15

---

## Funciones técnicas

Función de ahorro de energía .....	16
Hilos de amortiguación .....	16
Función Plug & Play .....	16
Modos predefinidos .....	17
Visualización de información sobre el monitor .....	17

---

## Información adicional

Mensajes de aviso .....	17
Solución de problemas .....	18
Función de autodiagnóstico .....	20
Especificaciones .....	20

## Precauciones

### Instalación

- Coloque el monitor en un lugar debidamente ventilado para evitar el recalentamiento interno. No lo sitúe sobre superficies (alfombras, mantas, etc.) o cerca de materiales (cortinas, tapices) que puedan bloquear los orificios de ventilación.
- No instale el monitor cerca de fuentes de calor como radiadores o tubos de ventilación, ni lo exponga a la luz directa del sol, a polvo excesivo, o a vibraciones o sacudidas mecánicas.
- Mantenga el monitor alejado de equipos que generan campos magnéticos, como transformadores o líneas eléctricas de alto voltaje.

### Mantenimiento

- Limpie el exterior, el panel y los controles con un paño suave ligeramente humedecido en una solución detergente poco concentrada. No utilice ningún tipo de estropajo, productos de limpieza en polvo ni disolventes, como alcohol o gasolina.
- Procure no friccionar, tocar ni golpear la superficie de la pantalla con objetos puntiagudos o abrasivos, como un bolígrafo o un destornillador. De lo contrario, este tipo de contacto puede dañar el tubo de imagen.
- Limpie la pantalla con un paño suave. Si utiliza algún líquido limpiador de cristales, no emplee ningún tipo de producto de limpieza que contenga soluciones antiestáticas o aditivos similares, ya que pueden rayar la superficie de la pantalla.

### Transporte

Al transportar este monitor para su reparación o traslado, embálelo en la caja de cartón y con los materiales de embalaje originales.

## Uso del soporte basculante giratorio

Este monitor puede ajustarse en los ángulos mostrados a continuación. Para encontrar el centro del radio de giro del monitor, alinee el centro de la pantalla de dicho monitor con los puntos de centrado del soporte.

Agarre el monitor por su parte inferior con las dos manos cuando lo gire horizontal o verticalmente. Tenga cuidado de no pillarse los dedos en la parte trasera del monitor cuando lo incline hacia arriba verticalmente.

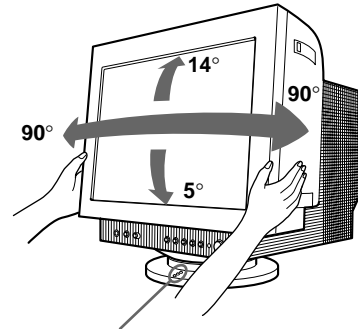

Puntos de centrado

### Nota

No quite el soporte basculante giratorio del monitor.

## Aviso sobre la conexión de la alimentación

- Utilice un cable de alimentación adecuado al suministro eléctrico local.

### Ejemplos de formas de enchufes:

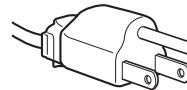

para 100 hasta  
120 V CA

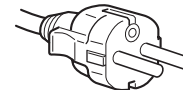

para 200 hasta  
240 V CA

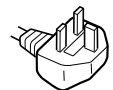

sólo para  
240 V CA

- Antes de desconectar el cable de alimentación, espere al menos 30 segundos después de apagar la unidad para permitir la descarga de la electricidad estática acumulada en la superficie del TRC.
- Tras activar la alimentación, el TRC se desmagnetiza durante 5 segundos aproximadamente. Este proceso genera un intenso campo magnético alrededor del marco metálico, que puede alterar los datos contenidos en las cintas o discos magnéticos situados en las proximidades. Por este motivo, es aconsejable mantener los equipos de grabación magnéticos y las cintas y discos alejados de este monitor.

La unidad debe instalarse cerca de una toma de corriente de fácil acceso.

## Identificación de los componentes y los controles

Consulte las páginas que se indican entre paréntesis para obtener descripciones más detalladas.

### Parte frontal

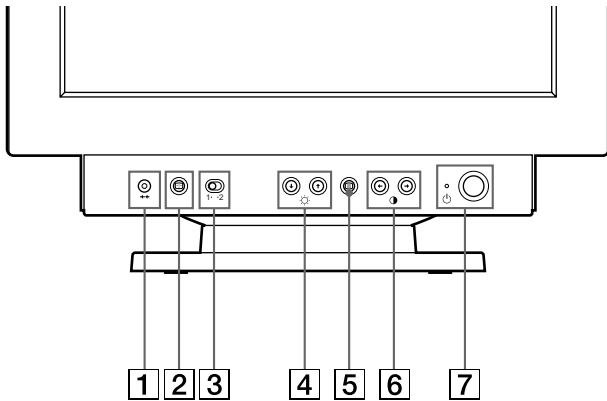

- 1 Botón <math>\leftarrow\rightarrow</math> (restauración) (página 15)**  
Recupera los niveles predefinidos de fábrica.
- 2 Botón <math>\oplus</math> (tamaño y centrado automáticos) (página 5)**  
Este botón ajusta automáticamente el tamaño y el centrado de la imagen.
- 3 Interruptor INPUT 1-2 (entrada) (página 5)**  
Este selector permite seleccionar el terminal INPUT 1 (conector 1 de entrada de vídeo) o INPUT 2 (conector 2 de entrada de vídeo).
- 4 Botones <math>\updownarrow</math> (brillo) arriba y abajo (<math>\downarrow/\uparrow</math>) (páginas 6-15)**  
Ajustan el brillo de la imagen.  
Funcionan como los botones (<math>\downarrow/\uparrow</math>) al ajustar otras opciones.
- 5 Botón <math>\equiv</math> (menú) (páginas 6-15, 17)**  
Muestra la indicación en pantalla MENU.
- 6 Botones <math>\blacktriangleleft/\blacktriangleright</math> (contraste) izquierda y derecha (<math>\leftarrow/\rightarrow</math>) (páginas 6-15, 20)**  
Ajustan el contraste.  
Funcionan como los botones (<math>\leftarrow/\rightarrow</math>) al ajustar otras opciones.
- 7 Interruptor e indicador de encendido <math>\text{⏻}</math> (páginas 16, 20)**  
Enciende o apaga el monitor.  
El indicador de alimentación se ilumina en verde cuando el monitor está encendido, y parpadea en verde y en naranja, o se ilumina en naranja cuando dicho monitor se encuentra en el modo de ahorro de energía.

### Parte posterior

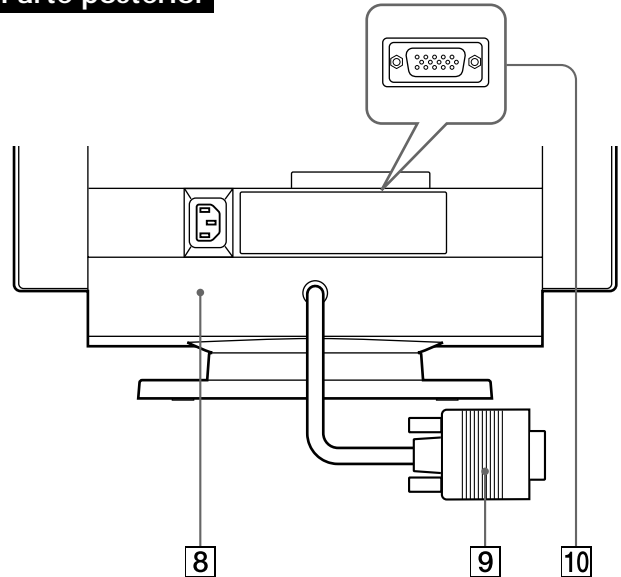

- 8 Conector AC IN (página 4)**  
Permite enchufar un cable de alimentación de CA al monitor.
- 9 Conector 1 de entrada de vídeo (HD15) (página 4)**  
Introduce las señales de vídeo RGB (0,700 Vp-p, positivas) y las SYNC.

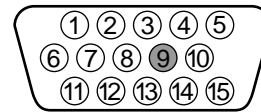

Nº de terminal	Señal	Nº de terminal	Señal
1	Rojo	10	Masa
2	Verde (Sincronización en verde)	11	Identificación (masa)
3	Azul	12	Datos bidireccionales (SDA)*
4	Identificación (masa)	13	Sincronización horizontal
5	Masa de DDC*	14	Sincronización vertical
6	Masa de rojo	15	Reloj de datos (SCL)*
7	Masa de verde		
8	Masa de azul		
9	—		

\* Norma Canal de Datos de Visualización (DDC) de VESA

- 10 Conector 2 de entrada de vídeo (HD15) (página 4)**  
Introduce las señales de vídeo RGB (0,700 Vp-p, positivas) y las SYNC.  
La asignación de terminales es la misma que la descrita en **9** anteriormente.

### Instalación

Este monitor funciona con plataformas que operen en frecuencias horizontales entre 30 y 107 kHz.

#### Paso 1: Asegúrese de que el ordenador y el monitor están apagados

#### Paso 2: Conecte el monitor al ordenador

Conecte el cable de señal de vídeo a la salida de vídeo del ordenador.

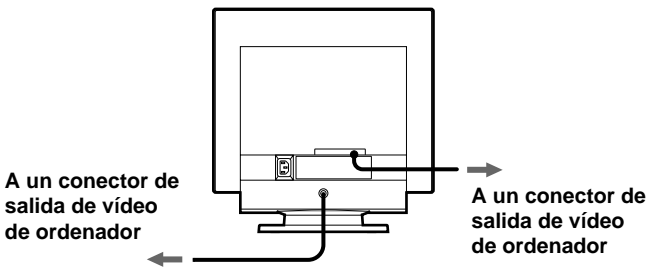

#### Nota

No cortocircuite los terminales del cable de señal de vídeo.

#### Paso 3: Conecte el cable de alimentación

Con el monitor apagado, conecte un extremo del cable de alimentación apropiado para la red local al monitor y el otro extremo a la toma de corriente.

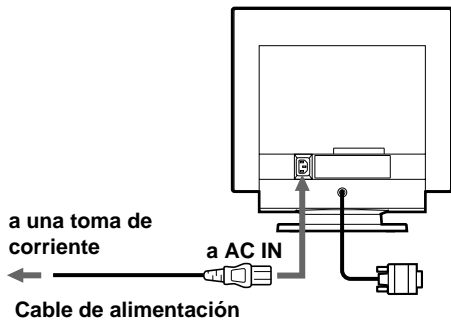

#### Paso 4: Encienda el monitor y el ordenador

#### Paso 5: Ajuste los controles del monitor según sus preferencias personales

La instalación del monitor está finalizada.

#### Nota

Si en lugar de una imagen, la pantalla muestra los mensajes "FUERA DEL RANGO DE AJUSTE" o "MONITOR EN MODO AHORRO ENERGIA", consulte "Mensajes de aviso" en la página 17.

#### Preparativos en el lugar de trabajo

##### Ubicación del monitor

Elija un lugar adecuado para instalar el monitor en el que se encuentre alejado de luces fluorescentes para escritorio o de cualquier equipo que produzca campos magnéticos y que pueda causar interferencias. Asegúrese de que el mueble o el equipo pueda soportar el peso del monitor. Deje un espacio libre de al menos 50 mm alrededor del monitor.

##### Altura

El monitor debe instalarse de forma que la parte superior de la pantalla quede ligeramente por debajo del nivel de los ojos cuando se sienta en su lugar de trabajo.

##### Orientación

Elija una posición en la que haya la menor cantidad posible de reflejos de luces y ventanas, normalmente en ángulo recto a cualquier ventana. El monitor debe colocarse directamente enfrente del usuario de forma que la postura del cuerpo sea natural. Inclíne el monitor con el fin de obtener un ángulo de visualización cómodo.

#### Hábitos de trabajo

##### Descanso

Descanse con regularidad. Cambie de postura, y levántese para estirar los músculos de vez en cuando, ya que el uso prolongado de ordenadores puede producir fatiga.

##### Espalda

Debe sentarse cómodamente en su silla y utilizar el respaldo.

##### Manos

Utilice las teclas del teclado con suavidad, manteniendo las manos y los dedos relajados. Deje un espacio enfrente del teclado para que las muñecas descansen cuando no esté escribiendo. Considere el empleo de una alfombrilla para muñecas.

##### Vista

La vista puede cansarse al trabajar con monitores, en general cuando realice trabajos que requieran mirar el monitor durante mucho tiempo. Retire la vista de la pantalla periódicamente y examínese dicha vista regularmente.

##### Ajustes de la pantalla

Ajuste el brillo y el contraste de la pantalla en niveles cómodos. Es posible que deba ajustarlos a medida que la iluminación cambie durante el día. Muchos programas de aplicación permiten seleccionar combinaciones de colores que pueden ayudar a ver con comodidad.

## Selección de la señal de entrada

Es posible conectar dos ordenadores a este monitor utilizando los conectores de entrada de vídeo 1 y 2. Para seleccionar uno de los dos ordenadores, utilice el interruptor INPUT 1-2.

Desplace el interruptor INPUT 1-2.

El conector seleccionado aparece en pantalla durante 3 segundos.



La pantalla muestra “SEÑAL 1” (conector 1 de entrada de vídeo) o “SEÑAL 2” (conector 2 de entrada de vídeo).

### Nota

Si el conector seleccionado no recibe ninguna señal, la pantalla mostrará el mensaje SIN SEÑAL DE ENTRADA. Transcurridos unos segundos, el monitor entra en el modo de ahorro de energía. Si esto ocurre, cambie al otro conector.

## Tamaño y centrado automáticos de la imagen

Es posible ajustar la imagen fácilmente para que llene la pantalla.

Para ello, basta con pulsar el botón  (tamaño y centrado automáticos).

Pulse el botón .

La imagen llenará automáticamente la pantalla.

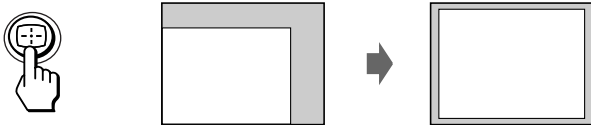

### Notas

- Esta función está destinada a emplearse con un ordenador que proporcione imágenes de pantalla completa. Puede no funcionar correctamente si el color de fondo es oscuro o si la imagen de entrada no llena la pantalla hasta los bordes.
- Las imágenes con una relación de aspecto de 5:4 (resolución: 1280 × 1024) aparecen con su resolución real y no llenan la pantalla hasta los bordes.
- La imagen mostrada se desplaza durante unos segundos al pulsar el botón . Esto no es un fallo de funcionamiento.

Antes de realizar los ajustes

- Conecte el monitor y el ordenador y enciéndalos.

## Selección del idioma de la indicación en pantalla

Si necesita cambiar el idioma de la indicación en pantalla, consulte “Uso de la indicación en pantalla LANGUAGE  (Idioma)” en la página 11.

El ajuste por omisión es el idioma inglés.

## Ajuste del brillo y contraste de la imagen



Una vez realizado el ajuste, se almacenará en la memoria para todas las señales de entrada recibidas.

- 1 Pulse los botones  (brillo)  /  o  (contraste)  / .

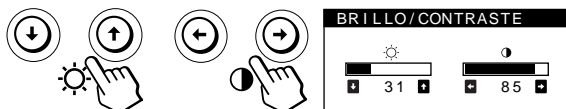
Aparece la indicación BRILLO/CONTRASTE.



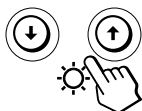

- 2 Para realizar el ajuste de brillo

Pulse los botones   / .



↑ ... para aumentar el brillo  
↓ ... para disminuir el brillo

Para realizar el ajuste de contraste

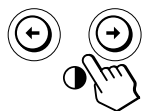

Pulse los botones   / .



→ ... para aumentar el contraste  
← ... para disminuir el contraste

La indicación desaparece automáticamente después de unos 3 segundos.

Para reajustar, pulse el botón  (restauración) mientras la indicación en pantalla aún se encuentre activada. Se restauran los valores de brillo y contraste predefinidos de fábrica.

Si selecciona sRGB “SI” como ajuste de color, el brillo () y el contraste () se fijarán automáticamente en “31” y “85”. Para obtener más información sobre sRGB, consulte “Uso de la indicación en pantalla COLOR ” en la página 9.





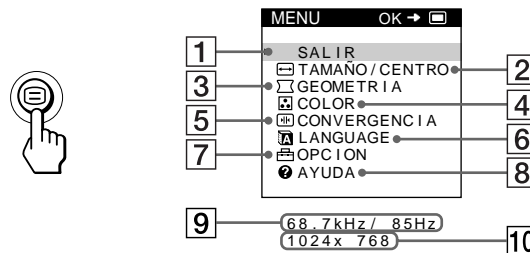

## Introducción al sistema de indicación en pantalla

La mayoría de los ajustes se realizan con la indicación en pantalla MENU.

### Indicación MENU

Pulse el botón  para visualizar la indicación MENU. Este MENU contiene vínculos con las otras indicaciones en pantalla descritas a continuación.



- 1 **SALIR**  
Cierra la indicación MENU.
- 2  **TAMAÑO/CENTRO**  
Muestra la indicación TAMAÑO/CENTRO para ajustar el tamaño, centrado y zoom de la imagen.
- 3  **GEOMETRIA**  
Muestra la indicación GEOMETRIA para ajustar la rotación y distorsión de la imagen, etc.
- 4  **COLOR**  
Muestra la indicación COLOR para ajustar la temperatura de color.
- 5  **CONVERGENCIA**  
Muestra la indicación CONVERGENCIA para ajustar la convergencia horizontal y vertical de la imagen.
- 6  **LANGUAGE**  
Muestra la indicación LANGUAGE para seleccionar un idioma.
- 7  **OPCION**  
Muestra la indicación OPCION para ajustar la posición de la indicación en pantalla, desmagnetizar la pantalla, etc.
- 8  **AYUDA**  
Muestra la indicación AYUDA para ver sugerencias útiles e información sobre este monitor.
- 9 **Las frecuencias horizontal y vertical de la señal de entrada actual**  
Se muestran las frecuencias horizontal y vertical de la señal de entrada actual.
- 10 **La resolución de la señal de entrada actual**  
Si la señal coincide con uno de los modos predefinidos en fábrica para este monitor, se muestra la resolución.



## Uso de la indicación en pantalla TAMAÑO/CENTRO

Los ajustes de TAMAÑO/CENTRO permiten ajustar el tamaño, centrado o zoom de la imagen.  
Una vez realizado el ajuste, se almacenará en memoria para la señal de entrada actual.

- 1 Pulse el botón .  
Aparece la indicación MENU.



- 2 Pulse los botones / para seleccionar " TAMAÑO/CENTRO" y vuelva a pulsar el botón .  
Aparece la indicación TAMAÑO/CENTRO.

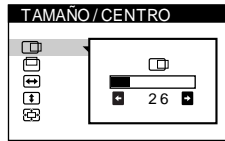
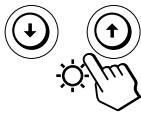

- 3 Pulse los botones / para seleccionar la opción que desea ajustar.

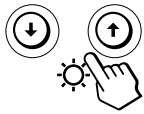

Seleccione	Para
(Centrado horizontal)	ajustar el centrado horizontal de la imagen
(Centrado vertical)	ajustar el centrado vertical de la imagen
(Tamaño horizontal)	ajustar el tamaño horizontal de la imagen
(Tamaño vertical)	ajustar el tamaño vertical de la imagen
(Zoom)	ampliar o reducir la imagen

- 4 Pulse los botones / para definir los ajustes.

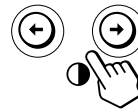

Seleccione	Para
(Centrado horizontal)	<p> ... desplazar la imagen hacia la derecha</p> <p> ... desplazar la imagen hacia la izquierda</p>
(Centrado vertical)	<p> ... desplazar la imagen hacia arriba</p> <p> ... desplazar la imagen hacia abajo</p>
(Tamaño horizontal)	<p> ... aumentar la anchura de la imagen</p> <p> ... reducir la anchura de la imagen</p>
(Tamaño vertical)	<p> ... aumentar la altura de la imagen</p> <p> ... reducir la altura de la imagen</p>
(Zoom)	<p> ... ampliar la imagen</p> <p> ... reducir la imagen</p>

Pulse el botón una vez para volver a la indicación MENU y dos veces para recuperar la visualización normal. Si no pulsa ningún botón, la indicación se cierra automáticamente después de unos 30 segundos.

Para reajustar, pulse el botón (restauración) mientras la indicación aún esté activada.  
Se restauran los valores predefinidos de fábrica de la opción seleccionada.

### Nota

El ajuste de (Zoom) se detiene en cuanto el tamaño horizontal o vertical alcanza su valor máximo o mínimo. El valor de ajuste horizontal no aparece en el menú.





## Uso de la indicación en pantalla GEOMETRIA

Los ajustes de GEOMETRIA permiten ajustar la forma y orientación de la imagen.



Una vez ajustado  (Rotación), se almacenará en memoria para todas las señales de entrada recibidas. El resto de ajustes se almacenarán en memoria para la señal de entrada actual.

- 1 Pulse el botón .  
Aparece la indicación MENU.



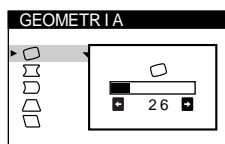
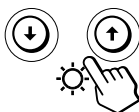



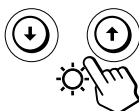

- 2 Pulse los botones / para seleccionar "  GEOMETRIA" y vuelva a pulsar el botón .  
Aparece la indicación GEOMETRIA.











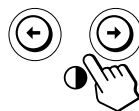

















- 3 Pulse los botones / para seleccionar la opción que desee ajustar.





Seleccione	Para
 (Rotación)	ajustar la rotación de la imagen
 (Distorsión de imagen)	ajustar los lados de la imagen
 (Balance de distorsión de imagen)	ajustar el balance lateral de la imagen
 (Distorsión trapezoidal)	ajustar la anchura de la imagen
 (Balance de distorsión trapezoidal)	ajustar el balance de la forma de la imagen

- 4 Pulse los botones / para realizar los ajustes.



Para	Pulse
 (Rotación)	<p> ... para rotar la imagen en el sentido de las agujas del reloj</p>  <p> ... para rotar la imagen en el sentido contrario a las agujas del reloj</p> 
 (Distorsión de imagen)	<p> ... para ampliar los lados de la imagen</p>  <p> ... para contraer los lados de la imagen</p> 
 (Balance de distorsión de imagen)	<p> ... para ampliar los lados de la imagen hacia la derecha</p>  <p> ... para ampliar los lados de la imagen hacia la izquierda</p> 
 (Distorsión trapezoidal)	<p> ... para aumentar la anchura de la imagen en la parte superior</p>  <p> ... para reducir la anchura de la imagen en la parte superior</p> 
 (Balance de distorsión trapezoidal)	<p> ... para desplazar la parte superior de la imagen hacia la derecha</p>  <p> ... para desplazar la parte superior de la imagen hacia la izquierda</p> 

Pulse el botón  una vez para volver a la indicación MENU y dos veces para recuperar la visualización normal. Si no pulsa ningún botón, la indicación se cierra automáticamente después de unos 30 segundos.

Para reajustar, pulse el botón  (restauración) mientras la indicación aún esté activada.

La opción seleccionada recupera el valor predefinido de fábrica.



## Uso de la indicación en pantalla COLOR

Es posible cambiar la temperatura de los colores del monitor. Por ejemplo, puede modificar los colores de una imagen en pantalla para que coincidan con los de la imagen impresa. Una vez realizado el ajuste, se almacenará en memoria para todas las señales de entrada recibidas.

1 Pulse el botón .

e c e r a p A





2 Pulse los botones / para seleccionar "COLOR" y vuelva a pulsar el botón .

e c e r a p A

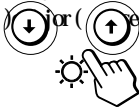
) o d a l u z a (



3 Pulse los botones / para seleccionar la temperatura del color.

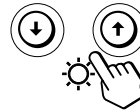



Existen dos modos de temperatura del color en la indicación en pantalla.

El ajuste predefinido es 9.300K.

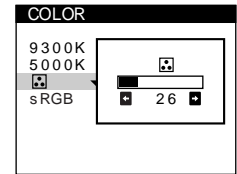
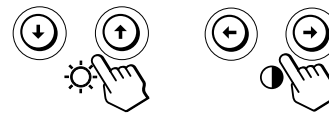
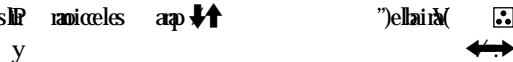
Selección de la temperatura del color entre 9.300K y 5.000K









Pulse el botón  una vez para volver a la indicación MENU y dos veces para recuperar la visualización normal. Si no pulsa ningún botón, la indicación se cierra automáticamente después de unos 30 segundos.

Para reajustar, pulse el botón  (restauración) mientras la indicación aún esté activada. Se restauran los valores predefinidos de fábrica para la temperatura de color seleccionada.

### Modo sRGB

El ajuste de color sRGB es un protocolo estándar de espacio de color diseñado para establecer una equivalencia entre los colores mostrados y los impresos mediante los productos informáticos compatibles con sRGB. Para ajustar los colores en el perfil sRGB, basta con seleccionar la opción sRGB "SI" en el menú COLOR. Sin embargo, para que los colores sRGB se muestren de forma correcta ( $\gamma=2,2$ , 6500K), es preciso definir el perfil sRGB en el ordenador.

Si selecciona sRGB "SI", el brillo () y el contraste () se fijarán automáticamente en "31" y "85". Si cambia el brillo () y el contraste (), el ajuste sRGB cambiará a "NO".

Para obtener información sobre cómo cambiar el brillo () y el contraste (), consulte la página 6.

### Nota

El ordenador y otros productos conectados (como una impresora) deben admitir el modo sRGB.

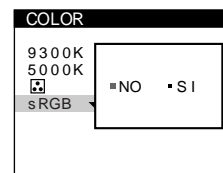

## Uso de la indicación en pantalla CONVERGENCIA





Los ajustes de CONVERGENCIA permiten ajustar la calidad de la imagen mediante el control de la convergencia. Ésta se refiere al alineamiento de las señales de color rojo, verde y azul.

Si se aprecian sombras rojas o azules alrededor de las letras o de las líneas, ajuste la convergencia.



Una vez realizado el ajuste, se almacenará en memoria para todas las señales de entrada recibidas.

- 1 Pulse el botón .  
Aparece la indicación MENU.



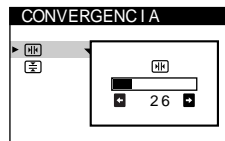
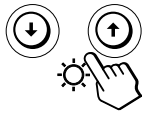



- 2 Pulse los botones / para seleccionar "  CONVERGENCIA" y vuelva a pulsar el botón .  
Aparece la indicación CONVERGENCIA.

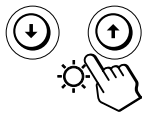







- 3 Pulse los botones / para seleccionar la opción que desee ajustar.

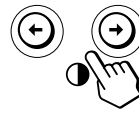



Seleccione	Para
 (Convergencia horizontal)	ajustar la convergencia horizontal
 (Convergencia vertical)	ajustar la convergencia vertical

- 4 Pulse los botones / para realizar los ajustes.



Para	Pulse
 (Convergencia horizontal)	<p> ... para desplazar las sombras rojas hacia la derecha y las azules hacia la izquierda</p> <p> ... para desplazar las sombras rojas hacia la izquierda y las azules hacia la derecha</p>
 (Convergencia vertical)	<p> ... para desplazar las sombras rojas hacia arriba y las azules hacia abajo</p> <p> ... para desplazar las sombras rojas hacia abajo y las azules hacia arriba</p>

Pulse el botón  una vez para volver a la indicación MENU y dos veces para recuperar la visualización normal. Si no pulsa ningún botón, la indicación se cierra automáticamente después de unos 30 segundos.





Para reajustar, pulse el botón  (restauración) mientras la indicación aún esté activada. Se restaura el ajuste predefinido de fábrica de la opción seleccionada.

## Uso de la indicación en pantalla LANGUAGE



Existen versiones de la indicación en pantalla en inglés, francés, alemán, español, italiano, holandés, sueco, ruso y japonés.

- 1 Pulse el botón .  
Aparece la indicación MENU.

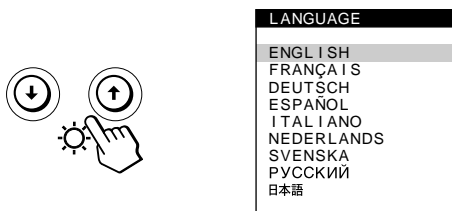

- 2 Pulse los botones / para seleccionar "  LANGUAGE" y vuelva a pulsar el botón .  
Aparece la indicación LANGUAGE.



- 3 Pulse los botones / para seleccionar el idioma que desee.

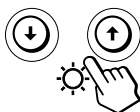

- ENGLISH: Inglés
- FRANÇAIS: Francés
- DEUTSCH: Alemán
- ESPAÑOL
- ITALIANO: Italiano
- NEDERLANDS: Holandés
- SVENSKA: Sueco
- РУССКИЙ: Ruso
- 日本語: Japonés

Pulse el botón  una vez para volver a la indicación MENU y dos veces para recuperar la visualización normal. Si no pulsa ningún botón, la indicación se cierra automáticamente después de unos 30 segundos.

Para recuperar el idioma inglés, pulse el botón  (restauración) mientras la indicación aún se encuentre activada.

## Uso de la indicación en pantalla OPCION

La indicación OPCION permite desmagnetizar la pantalla manualmente, definir el nivel de cancelación de muaré y ajustar la posición de la indicación. También permite bloquear los controles.





### Desmagnetización de la pantalla

La pantalla del monitor se desmagnetiza automáticamente cuando se enciende la unidad.



También es posible desmagnetizarla de forma manual.

- 1 Pulse el botón .  
Aparece la indicación MENU.

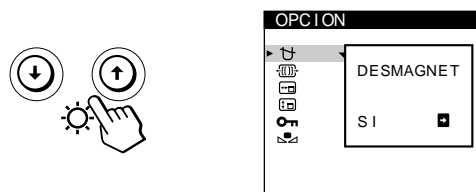

- 2 Pulse los botones / para seleccionar "  OPCION" y vuelva a pulsar el botón .  
Aparece la indicación OPCION.



- 3 Pulse los botones / para seleccionar "  (DESMAGNET)".

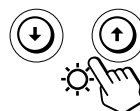

- 4 Pulse el botón .  
La pantalla se desmagnetiza durante unos 5 segundos.



Si necesita desmagnetizar la pantalla por segunda vez, espere al menos 20 minutos antes de repetir los pasos anteriores.



Pulse el botón  una vez para volver a la indicación MENU y dos veces para recuperar la visualización normal. Si no pulsa ningún botón, la indicación se cierra automáticamente después de unos 30 segundos.

## Ajuste del muaré



Si en la pantalla aparecen patrones elípticos u ondulados, ajuste el nivel de cancelación de muaré.

- 1 Pulse el botón .  
Aparece la indicación MENU.

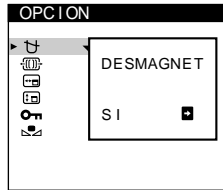
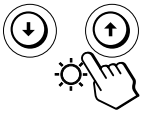

- 2 Pulse los botones  para seleccionar "  OPCION" y vuelva a pulsar el botón .  
Aparece la indicación OPCION.



- 3 Pulse los botones  para seleccionar "  AJUSTE MUARE\*".

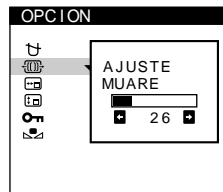
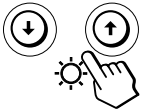

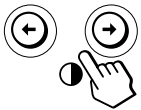

- 4 Para ajustar el nivel de cancelación de muaré, pulse los botones  hasta que el efecto muaré quede ajustado en el mínimo.

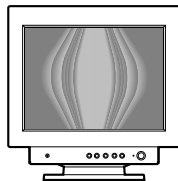

\* El muaré es un tipo de interferencia natural que produce la aparición de líneas suaves y onduladas en pantalla. Puede deberse a la interferencia entre el patrón de la imagen en pantalla y el de paso de fósforo del monitor.

Ejemplo de muaré:



Pulse el botón  una vez para volver a la indicación MENU y dos veces para recuperar la visualización normal. Si no pulsa ningún botón, la indicación se cierra automáticamente después de unos 30 segundos.



Para reajustar, pulse el botón  (restauración) mientras la indicación se encuentra activada.

## Cambio de la posición de la indicación en pantalla





Es posible cambiar la posición de la indicación (por ejemplo, si desea ajustar la imagen que se encuentra detrás de ella).

- 1 Pulse el botón .  
Aparece la indicación MENU.

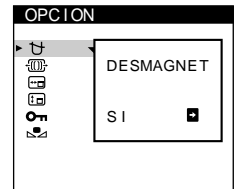
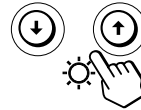

- 2 Pulse los botones  para seleccionar "  OPCION" y vuelva a pulsar el botón .  
Aparece la indicación OPCION.



- 3 Pulse los botones  para seleccionar "  (POSICION MENU H)" o "  (POSICION MENU V)".  
Seleccione "  (POSICION MENU H)" para ajustar la posición horizontal.

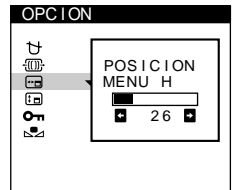
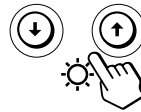

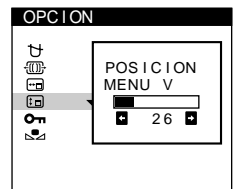
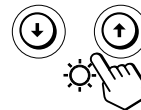

Seleccione "  (POSICION MENU V)" para ajustar la posición vertical.

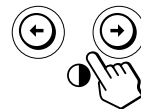

- 4 Pulse los botones  para desplazar la indicación en pantalla hasta la posición que desee.



Pulse el botón  una vez para volver a la indicación MENU y dos veces para recuperar la visualización normal. Si no pulsa ningún botón, la indicación se cierra automáticamente después de unos 30 segundos.





Para reajustar, pulse el botón  (restauración) mientras la indicación aún se encuentre activada.

## Bloqueo de los controles

La información de los ajustes se puede proteger bloqueando los controles.

- 1 Pulse el botón .  
Aparece la indicación MENU.



- 2 Pulse los botones   para seleccionar "  OPCION" y vuelva a pulsar el botón .  
Aparece la indicación OPCION.

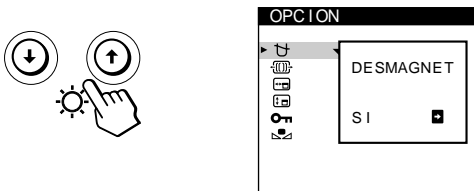



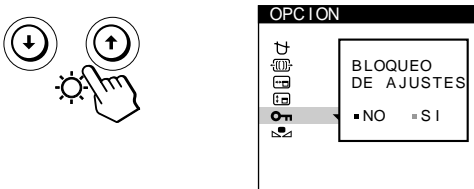

- 3 Pulse los botones   para seleccionar "  (BLOQUEO DE AJUSTES)".

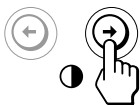

- 4 Pulse el botón  para seleccionar "SI".



Pulse el botón  una vez para volver a la indicación MENU y dos veces para recuperar la visualización normal. Si no pulsa ningún botón, la indicación se cierra automáticamente después de unos 30 segundos.

Sólo funcionarán el interruptor  (de encendido), SALIR y "  (BLOQUEO DE AJUSTES)" de la indicación "  OPCION". Si se selecciona alguna otra opción, la marca  aparecerá en pantalla.

### Para cancelar el bloqueo de los controles





Repita los pasos 1 a 3 anteriores y pulse el botón  para seleccionar "NO".

## Recuperación del color



En la mayoría de los monitores, el color suele perder luminosidad de forma gradual después de varios años de servicio. La función REAJUSTE DE COLOR permite recuperar los niveles originales de calidad definidos en fábrica para el color. A continuación, se describe cómo restaurar el color del monitor.

- 1 Pulse el botón .  
Aparece la indicación MENU.

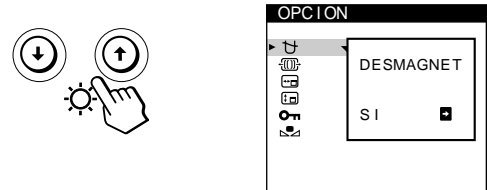

- 2 Pulse los botones   para seleccionar "  OPCION" y vuelva a pulsar el botón .  
Aparece la indicación OPCION.



- 3 Pulse los botones   para seleccionar "  (REAJUSTE DE COLOR)".

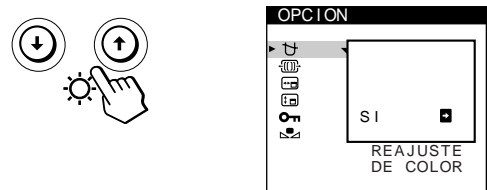

- 4 Pulse el botón  para seleccionar "SI".



La imagen desaparece mientras el color se restaura (aproximadamente 2 segundos). Una vez restaurado el color, la imagen vuelve a aparecer en pantalla.

Pulse el botón  una vez para volver a la indicación MENU y dos veces para recuperar la visualización normal. Si no pulsa ningún botón, la indicación se cierra automáticamente después de unos 30 segundos.

## Notas

- Antes de emplear esta función, el monitor debe encontrarse en el modo de funcionamiento normal (indicador de alimentación iluminado en verde) durante al menos 30 minutos. Si el monitor entra en el modo de ahorro de energía, deberá ajustar dicho monitor en el modo de funcionamiento normal y esperar unos 30 minutos para que esté preparado. Es posible que sea necesario definir los ajustes de ahorro de energía del ordenador para que el monitor se mantenga en el modo de funcionamiento normal durante 30 minutos completos. Si el monitor no está preparado, aparecerá el siguiente mensaje.

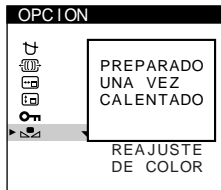





- El monitor puede perder gradualmente la capacidad para realizar esta función debido al desgaste natural del tubo de imagen.

## Uso de la indicación en pantalla AYUDA



El menú AYUDA contiene sugerencias e información útiles sobre este monitor. Si éste muestra síntomas que coincidan con los enumerados en el menú AYUDA, siga las instrucciones en pantalla para solucionar el problema. Si los síntomas no coinciden con los enumerados en dicho menú AYUDA o si el problema persiste, consulte “Solución de problemas” en la página 18.

- 1 Pulse el botón .  
Aparece la indicación MENU.

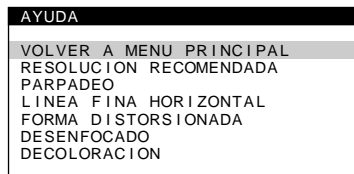
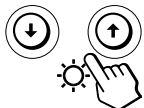

- 2 Pulse los botones   para seleccionar “ AYUDA” y vuelva a pulsar el botón .



- 3 Pulse los botones   para seleccionar una opción del menú AYUDA.  
Las instrucciones o la información para solucionar el problema aparecen en pantalla. A continuación, se incluye una explicación de cada opción del menú.

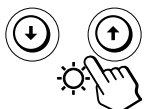

## RESOLUCION RECOMENDADA

Si la imagen no llena la pantalla hasta los bordes o si dicha imagen aparece con un tamaño excesivo con respecto a la pantalla, ajuste la resolución con el ordenador teniendo en cuenta los datos mostrados en el menú. Si la señal de entrada se corresponde con uno de los modos de este monitor predefinidos en fábrica, aparecerán la resolución y la frecuencia de barrido de la señal de entrada actual.

## PARPADEO

Si la imagen parpadea, ajuste la frecuencia de barrido teniendo en cuenta los datos mostrados en el menú. Si la señal de entrada se corresponde con uno de los modos de este monitor predefinidos en fábrica, aparecerá la frecuencia de barrido de la señal de entrada actual.

## LINEA FINA HORIZONTAL

Las líneas que aparecen en pantalla son hilos de amortiguación. Consulte la página 16 para obtener más información sobre éstos.



## FORMA DISTORSIONADA

Si la forma de la imagen en pantalla aparece distorsionada, ajuste la geometría de la imagen. Pulse el botón  para pasar directamente a la indicación GEOMETRIA.

## DESENFOCADO

La imagen puede aparecer desenfocada si las señales de color rojo y azul no están correctamente alineadas, produciendo sombras rojas o azules alrededor de las letras y las líneas. Ajuste la convergencia de la imagen para que las sombras desaparezcan. Pulse el botón  para pasar directamente a la indicación CONVERGENCIA. Al aparecer ésta, los ajustes de contraste, brillo y muaré se restaurarán automáticamente para todas las señales de entrada.

## DECOLORACION



Si el color de la imagen se muestra anormal en ciertas partes de la pantalla, compruebe en primer lugar si hay algún cable de señal suelto. Una vez examinados los cables, desmagnetice la pantalla manualmente. Pulse el botón  para pasar directamente a la indicación OPCION y, a continuación, seleccione  (DESMAGNET).

Pulse el botón  una vez para volver a la indicación MENU y dos veces para recuperar la visualización normal. Si no pulsa ningún botón, la indicación se cierra automáticamente después de unos 30 segundos.





## Restauración de los ajustes de fábrica

### Reajuste de una opción

- 1 Pulse los botones  y  para seleccionar la indicación que contenga la opción que desee restaurar, y vuelva a pulsar el botón .



- 2 Pulse los botones  y  para seleccionar la opción que desee reajustar.

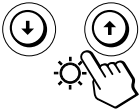

- 3 Pulse el botón  (restauración).

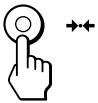

### Restauración de todos los datos de ajuste para la señal de entrada actual

Sin ninguna indicación en pantalla, pulse el botón  (restauración).

Se restauran los ajustes predefinidos de fábrica de todos los datos de ajuste para la señal de entrada actual.

Tenga en cuenta que la restauración de la señal actual no afecta al brillo, contraste, idioma y posición de la indicación en pantalla ni al bloqueo de los controles.

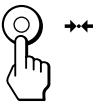



### Restauración de todos los datos de ajuste para todas las señales de entrada

Pulse y mantenga pulsado el botón  (restauración) durante más de dos segundos.

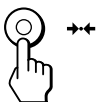
Se restauran los ajustes predefinidos de fábrica de todos los datos de ajuste, incluidos el brillo y contraste.



#### Nota

El botón  (restauración) no funciona cuando  (BLOQUEO DE AJUSTES) está ajustado en SI.

## Función de ahorro de energía

Este monitor cumple las directrices de ahorro de energía establecidas por VESA y ENERGY STAR, así como las más exigentes directrices de NUTEK.

Si el monitor está conectado a un ordenador o tarjeta gráfica de vídeo que cumpla con VESA DPMS (Display Power Management Signaling), dicho monitor reducirá automáticamente el consumo de energía en tres fases, como se muestra a continuación.

### Notas

- Cuando el ordenador se encuentra en el modo de ahorro de energía, el mensaje MONITOR EN MODO AHORRO ENERGIA aparece en pantalla al pulsar cualquier botón del monitor (página 17). Transcurridos unos segundos, el monitor vuelve al modo de ahorro de energía. Una vez detectadas las señales de sincronización horizontal y vertical, el monitor recupera automáticamente el modo de funcionamiento normal.
- La función de gestión de energía se activa cuando el ordenador reconoce que no se ha utilizado el ratón o el teclado durante un espacio de tiempo definible por el usuario.
- IBM recomienda que apague el monitor al final de cada sesión laboral, o cuando no vaya a utilizarlo durante mucho tiempo en el día.

	Modo de consumo de energía	Pantalla	Señal de sincronización horizontal	Señal de sincronización vertical	Consumo de energía	Tiempo de recuperación	Indicador 
1	Funcionamiento normal	activa	presente	presente	≤ 140 W	—	Verde
2	Modo de espera (1er estado)	en blanco	ausente	presente	≤ 15 W	Aprox. 5 seg.	Verde y naranja alternos
3	Modo de reposo (2º estado) (sleep)*	en blanco	presente	ausente	≤ 15 W	Aprox. 5 seg.	Verde y naranja alternos
4	Activo-inactivo (3er estado) (deep sleep)*	en blanco	ausente	ausente	≤ 3 W	Aprox. 15 seg.	Naranja
5	Apagado	—	—	—	≤ 0,5 W	—	Apagado

\* “Sleep” y “deep sleep” son modos de ahorro de energía definidos por la Agencia de protección del medio ambiente (Environmental Protection Agency).

## Hilos de amortiguación

Al visualizar un fondo blanco, es posible que se vean en pantalla líneas horizontales muy finas, como se muestra a continuación. Dichas líneas son las sombras de los hilos de amortiguación y son características de los TRC con rejillas de apertura. Los hilos están unidos a la rejilla de apertura del interior del tubo Trinitron y evitan la vibración de dicha rejilla.

Hilos de amortiguación

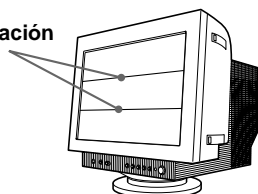

## Función Plug & Play

Este monitor cumple las normas de Canal de Datos de Visualización (DDC) DDC1, DDC2B y DDC2Bi de VESA. Cuando se conecta un sistema central DDC1, el monitor se sincroniza con V. CLK de acuerdo con las normas VESA y transmite los Datos de Identificación de Visualización Extendidos (EDID) a la línea de datos. Cuando se conecta con un sistema central DDC2B o DDC2Bi, el monitor cambia automáticamente a la norma adecuada.

## Modos predefinidos

Nº	Resolución (puntos × líneas)	Frecuencia horizontal	Frecuencia vertical	Modo gráfico
1	640 × 480	31,5 kHz	60 Hz	VGA
2	640 × 480	43,3 kHz	85 Hz	VESA
3	800 × 600	46,9 kHz	75 Hz	VESA
4	800 × 600	53,7 kHz	85 Hz	VESA
5	1024 × 768	60,0 kHz	75 Hz	VESA
6	1024 × 768	68,7 kHz	85 Hz	VESA
7	1280 × 1024	80,0 kHz	75 Hz	VESA
8	1280 × 1024	91,1 kHz	85 Hz	VESA
9	1600 × 1200	93,8 kHz	75 Hz	VESA
10	1600 × 1200	106,3 kHz	85 Hz	VESA

## Visualización de información sobre el monitor

Es posible visualizar el nombre del modelo, número de serie y año de fabricación mediante la indicación en pantalla INFORMACION del monitor.

Pulse y mantenga pulsado el botón  durante 3 segundos.

Aparece la indicación INFORMACION.

Ejemplo:

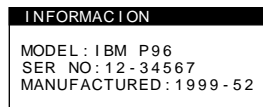

La indicación INFORMACION incluye el nombre del modelo, el número de serie y el año de fabricación.

La indicación desaparece automáticamente después de unos 30 segundos.

## Mensajes de aviso

Si no aparece ninguna imagen en la pantalla, ésta mostrará, uno de los siguientes mensajes. Para solucionar el problema, consulte “Solución de problemas” en la página 18.

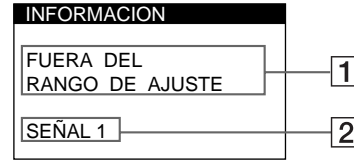

### 1 Condición de la señal de entrada

#### FUERA DEL RANGO DE AJUSTE

indica que las especificaciones del monitor no admiten la señal de entrada.

#### SIN SEÑAL DE ENTRADA

indica que no se introduce ninguna señal.

#### MONITOR EN MODO AHORRO ENERGIA







indica que el ordenador se encuentra en el modo de ahorro de energía. Este mensaje sólo aparece cuando el ordenador se encuentra en algún modo de ahorro de energía y pulsa cualquier botón del monitor.

### 2 Conector seleccionado

Este mensaje muestra qué conector se encuentra actualmente seleccionado (SEÑAL 1 o SEÑAL 2).

## Solución de problemas

Esta sección puede ayudarle a localizar un problema y, por consiguiente, eliminar la necesidad de llamar al soporte técnico.

Síntoma	Compruebe lo siguiente
<b>No aparece ninguna imagen</b>	
No está iluminado el indicador 	<ul style="list-style-type: none"> <li>• Asegúrese de que el cable de alimentación está correctamente conectado.</li> <li>• Compruebe que el interruptor  (de encendido) se encuentra en la posición de activado.</li> </ul>
Si el mensaje “SIN SEÑAL DE ENTRADA” aparece en la pantalla, o si el indicador  se ilumina en naranja o alterna entre el verde y el naranja	<ul style="list-style-type: none"> <li>• Cerciórese de que el interruptor de encendido del ordenador está en la posición de activado.</li> <li>• Compruebe que el ajuste del interruptor INPUT 1-2 sea correcto (página 5).</li> <li>• Asegúrese de que el cable de señal de vídeo está debidamente conectado y que todos los enchufes están perfectamente encajados en las clavijas.</li> <li>• Compruebe que no haya terminales doblados ni torcidos en el conector de entrada de vídeo.</li> <li>• Compruebe que la tarjeta gráfica se encuentra completamente insertada en la ranura de bus adecuada.</li> </ul>
Si el mensaje “MONITOR EN MODO AHORRO ENERGIA” aparece en la pantalla, o si el indicador  se ilumina en naranja o alterna entre el verde y el naranja	<ul style="list-style-type: none"> <li>• El ordenador está en el modo de ahorro de energía. Pulse cualquier tecla del teclado del ordenador o mueva el ratón.</li> <li>• Cerciórese de que el interruptor de encendido del ordenador está en la posición de activado.</li> <li>• Compruebe que la tarjeta gráfica se encuentra completamente insertada en la ranura de bus adecuada.</li> </ul>
Si el mensaje “FUERA DEL RANGO DE AJUSTE” aparece en pantalla	<ul style="list-style-type: none"> <li>• Compruebe que el rango de frecuencia de vídeo se encuentra dentro del especificado para el monitor. (Horizontal: 30 – 107 kHz Vertical: 48 – 120 Hz) Consulte el manual de instrucciones del ordenador para ajustar el rango de frecuencia de vídeo.</li> <li>• Si utiliza un adaptador de cable de señal de vídeo, compruebe que sea correcto.</li> </ul>
Si no aparece ningún mensaje y el indicador  se ilumina en color verde o parpadea en color naranja	<ul style="list-style-type: none"> <li>• Consulte “Función de autodiagnóstico” (página 20).</li> </ul>
<b>La imagen aparece codificada</b>	<ul style="list-style-type: none"> <li>• Consulte el ajuste de monitor apropiado en el manual de la tarjeta gráfica.</li> <li>• Revise este manual y confirme que se admiten el modo gráfico y la frecuencia a la que está operando. Incluso si la frecuencia está en el intervalo adecuado, algunas tarjetas gráficas pueden tener un impulso de sincronización demasiado estrecho para que el monitor se sincronice correctamente.</li> </ul>
<b>El color no es uniforme</b>	<ul style="list-style-type: none"> <li>• Desmagnetice el monitor (página 11). Si sitúa un equipo que genera un campo magnético, como un altavoz, cerca del monitor o cambia la dirección de éste, el color puede dejar de ser uniforme. Esta función permite desmagnetizar el armazón metálico del TRC a fin de obtener un campo neutro en el que la reproducción de los colores es uniforme. Si necesita aplicar un segundo ciclo de desmagnetización, deje que transcurran al menos 20 minutos para obtener unos resultados óptimos.</li> </ul>
<b>No puede ajustar el monitor con los botones del panel frontal</b> (  aparece en pantalla)	<ul style="list-style-type: none"> <li>• Si la función de bloqueo de los controles está activada (SI), desactívela (NO) mediante la indicación OPCION (página 13).</li> </ul>
<b>El blanco no parece blanco</b>	<ul style="list-style-type: none"> <li>• Ajuste la temperatura del color (página 9).</li> </ul>

Síntoma	Compruebe lo siguiente
La imagen no está centrada en pantalla o tiene un tamaño incorrecto	<ul style="list-style-type: none"> <li>• Pulse el botón  (página 5).</li> <li>• Ajuste el tamaño o centrado (página 7). Algunos modos de vídeo no permiten ocupar la pantalla hasta los bordes. Este problema suele producirse con determinadas tarjetas gráficas.</li> </ul>
Los bordes de la imagen son curvos	<ul style="list-style-type: none"> <li>• Ajuste la geometría (página 8).</li> </ul>
Las líneas blancas muestran sombras rojas o azules en los bordes	<ul style="list-style-type: none"> <li>• Ajuste la convergencia (página 10).</li> </ul>
La imagen aparece borrosa	<ul style="list-style-type: none"> <li>• Ajuste el contraste y brillo (página 6).</li> <li>• Desmagnetice el monitor (página 11). Si sitúa un equipo que genera un campo magnético, como un altavoz, cerca del monitor o cambia la dirección de éste, el color puede dejar de ser uniforme. Esta función permite desmagnetizar el armazón metálico del TRC a fin de obtener un campo neutro en el que la reproducción de los colores es uniforme. Si necesita aplicar un segundo ciclo de desmagnetización, deje que transcurran al menos 20 minutos para obtener unos resultados óptimos.</li> <li>• Si aparecen sombras rojas o azules a lo largo de los bordes de las imágenes, ajuste la convergencia (página 10).</li> <li>• Seleccione ELIMINAR MUARE y ajuste el efecto de cancelación de muaré (página 12).</li> </ul>
La imagen salta o sufre oscilaciones	<ul style="list-style-type: none"> <li>• Aíse y elimine las fuentes potenciales de campos eléctricos o magnéticos. Algunas causas frecuentes de este síntoma son los ventiladores eléctricos, las luces fluorescentes y las impresoras láser.</li> <li>• Si ha instalado otro monitor en las inmediaciones, aumente la distancia entre ambos para reducir la interferencia.</li> <li>• Enchufe el monitor a una toma de CA diferente, a ser posible en un circuito distinto.</li> <li>• Pruebe el monitor con otro ordenador y en una habitación distinta.</li> </ul>
La imagen parpadea	<ul style="list-style-type: none"> <li>• Defina el índice de barrido en el ordenador para obtener una imagen con la mayor calidad posible; para ello, consulte el manual del ordenador.</li> </ul>
Aparecen imágenes fantasma	<ul style="list-style-type: none"> <li>• Si detecta este síntoma, evite el uso de cables prolongadores de vídeo y/o de cajas conmutadoras de vídeo. Puede deberse a la longitud excesiva de los cables o a una conexión débil.</li> </ul>
Se observa en pantalla una trama ondulada o elíptica (muaré)	<ul style="list-style-type: none"> <li>• Seleccione ELIMINAR MUARE y ajuste el efecto de cancelación de muaré (página 12). El efecto muaré puede modificarse en función del ordenador conectado.</li> <li>• Cambie el patrón de escritorio. Debido a la relación entre la resolución, el paso de puntos del monitor y el paso de determinados patrones de imagen, ciertos fondos de pantalla muestran muaré ocasionalmente.</li> </ul>
Se observan dos líneas horizontales finas	<ul style="list-style-type: none"> <li>• Estas líneas sirven para estabilizar la rejilla de apertura vertical (página 16). La rejilla de apertura admite el paso de mayor cantidad de luz a través de la pantalla, aumentando así la intensidad de color y el brillo del TRC de Trinitron.</li> </ul>
La función REAJUSTE DE COLOR no se activa	<ul style="list-style-type: none"> <li>• Antes de emplear esta función, el monitor debe encontrarse en el modo de funcionamiento normal (indicador de alimentación iluminado en verde) durante al menos 30 minutos. Para obtener más información sobre el empleo de la función REAJUSTE DE COLOR, consulte "Recuperación del color" la página 13.</li> <li>• Defina los ajustes de ahorro de energía del ordenador para mantener el monitor en el modo de funcionamiento normal durante más de 30 minutos.</li> <li>• El monitor puede perder gradualmente su capacidad para realizar esta función debido al desgaste natural del tubo de imagen.</li> </ul>
Se oye un zumbido tras encender la unidad	<ul style="list-style-type: none"> <li>• Cuando se enciende el monitor, se activa el ciclo de desmagnetización. Es posible que oiga un zumbido mientras este ciclo se encuentra activado. Se oye el mismo zumbido al desmagnetizar el monitor manualmente. No se trata de un funcionamiento defectuoso.</li> </ul>

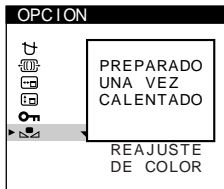



- Si el problema persiste, llame al IBM HelpCenter.  
En EE.UU., llame al 1-800-772-2227  
En Canadá, llame al 1-800-565-3344
- Anote el nombre del modelo y el número de serie de su monitor. Además, tome nota de la marca y el nombre de su ordenador y de la tarjeta gráfica.

### Función de autodiagnóstico

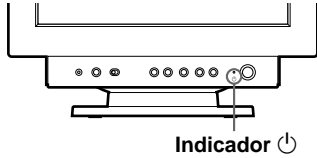
Este monitor está equipado con una función de autodiagnóstico. Si el monitor o el ordenador presenta algún problema, la pantalla se mostrará en blanco y el indicador  se iluminará en verde o parpadeará en naranja.



#### Si el indicador se ilumina en color verde

- 1 Desconecte el cable de entrada de vídeo o apague el ordenador conectado.
- 2 Pulse el botón  dos veces para apagar y volver a encender el monitor.
- 3 Mantenga pulsado el botón  durante 2 segundos antes de que el monitor entre en el modo de ahorro de energía.

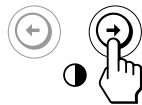



Si aparecen cuatro barras de color (blanco, rojo, verde, azul), el monitor funciona correctamente. Vuelva a conectar el cable de entrada de vídeo y compruebe el estado del ordenador.

Si las barras de color no aparecen, es posible que se deba a un fallo del monitor. Informe al IBM HelpCenter sobre el estado del monitor.

#### Si el indicador parpadea en color naranja

Pulse el botón  dos veces para apagar y volver a encender el monitor.

Si el indicador  se ilumina en color verde, el monitor está funcionando correctamente.

Si el indicador  aún parpadea, existe un fallo potencial del monitor. Informe al IBM HelpCenter sobre el estado del monitor. Asegúrese de anotar el nombre del modelo y el número de serie del monitor. Igualmente, tome nota del fabricante y del modelo del ordenador y de la tarjeta de vídeo.

### Especificaciones

Tubo de imagen	Paso de rejilla de apertura de 0,24 mm 19 pulgadas en diagonal Deflexión, 90 grados
Tamaño de imagen visualizable	Aprox. 365 × 274 mm (an/al) Imagen de visualización de 18,0 pulgadas
Resolución	Horizontal: Máx. 1600 puntos Vertical: Máx. 1200 líneas
Area estándar de la imagen	Aprox. 352 × 264 mm (an/al)
Frecuencia de deflexión*	Horizontal: 30 a 107 kHz Vertical: 48 a 120 Hz 256 < Línea Total < 2048
Tensión/intensidad de entrada CA	100 a 240 V, 50 – 60 Hz, Máx. 2,0 A
Consumo de energía	Máx. 140 W
Temperatura de funcionamiento	10°C a 40°C
Dimensiones	462 × 462 × 474 mm (an/al/pf)
Peso	Aprox. 27 kg

\* Condición de sincronización horizontal y vertical recomendada

- La anchura de sincronización horizontal debe ser superior a 1,0 µseg.
- La anchura de supresión horizontal debe ser superior a 3,0 µseg.
- La anchura de supresión vertical debe ser superior a 450 µseg.

Diseño y especificaciones sujetos a cambios sin previo aviso.

**Italiano**

# Prima edizione

Questo documento potrebbe contenere informazioni tecniche non accurate o errori tipografici. Il documento viene tuttavia aggiornato periodicamente. Eventuali correzioni e modifiche saranno pertanto implementate nelle edizioni successive. La IBM si riserva il diritto di migliorare e/o modificare i prodotti e/o i programmi in qualsiasi momento.

Il documento potrebbe includere riferimenti o informazioni su prodotti (computer e programmi), elementi di programmazione o servizi IBM non disponibili nel paese di pubblicazione del documento.

È possibile richiedere copie del documento e informazioni tecniche sui prodotti IBM a un rappresentante autorizzato o a un rivenditore IBM.

Nessuna parte di questo documento può essere riprodotta o distribuita in qualsiasi forma o tramite qualsiasi mezzo senza previa autorizzazione scritta della International Business Machines Corporation.

I riferimenti a prodotti, programmi o servizi IBM contenuti nel documento non implicano la disponibilità dei prodotti, programmi o servizi citati in tutti i paesi in cui la IBM opera. Tali riferimenti non dichiarano né implicano che debbano essere utilizzati esclusivamente i prodotti, programmi o servizi IBM a cui viene fatto riferimento. È infatti possibile utilizzare qualsiasi altro prodotto, programma o servizio equivalente dal punto di vista funzionale che non violi i diritti di proprietà intellettuali della IBM o altri diritti protetti legalmente. La valutazione e la verifica del funzionamento con altri prodotti, programmi o servizi, ad eccezione di quelli indicati espressamente dalla IBM, sono responsabilità dell'utente.

La IBM potrebbe possedere brevetti o applicazioni brevettate in sospenso correlati al contenuto di questo documento. La disponibilità del presente documento tuttavia non comporta alcuna licenza d'uso di tali brevetti.

## Marchi di fabbrica

I seguenti nomi utilizzati nel documento sono marchi di fabbrica o di servizi della IBM Corporation negli Stati Uniti e in altri paesi:

### **IBM VGA HelpCenter**

- ENERGY STAR è un marchio registrato negli U.S.A.
- Trinitron® è un marchio di fabbrica registrato di Sony Corporation.
- DDC™ è un marchio di fabbrica di Video Electronics Standard Association.
- VESA è un marchio di fabbrica di Video Electronics Standard Association.
- Tutti i nomi degli altri prodotti citati in questo manuale potrebbero essere marchi di fabbrica o marchi di fabbrica registrati delle rispettive società.
- Inoltre “™” e “®” non sempre vengono riportati nel manuale.

© Copyright International Business Machines Corporation 1999.  
Tutti i diritti riservati.



# INDICE







---

## Operazioni preliminari

Precauzioni .....	2
Identificazione dei componenti e dei comandi .....	3
Installazione .....	4
Selezione del segnale di ingresso .....	5
Redimensionamento e centratura automatici dell'immagine .....	5

---

## Personalizzazione del monitor

Selezione della lingua per l'indicazione a schermo (OSD) .....	6
Regolazione della luminosità e del contrasto dell'immagine .....	6
Il sistema di indicazione a schermo .....	6
Uso dell'indicazione a schermo DIMENS/CENTR.  .....	7
Uso dell'indicazione a schermo GEOMETRIA  .....	8
Uso dell'indicazione a schermo COLORE  .....	9
Uso dell'indicazione a schermo CONVERGENZA  .....	10
Uso dell'indicazione a schermo LANGUAGE  .....	11
Uso dell'indicazione a schermo OPZIONI  .....	11
Utilizzo dell'indicazione a schermo GUIDA  .....	14
Reimpostazione dei dati di regolazione .....	15

---

## Caratteristiche tecniche

Funzione di risparmio energetico .....	16
Cavi di smorzamento .....	16
Uso immediato .....	16
Modi preimpostati .....	17
Visualizzazione delle informazioni sul monitor .....	17

---

## Informazioni aggiuntive

Messaggi di avvertimento .....	17
Guida alla soluzione dei problemi .....	18
Funzione di autodiagnostica .....	20
Caratteristiche tecniche .....	20

### Precauzioni

#### Installazione

- Evitare il surriscaldamento interno consentendo un'adeguata circolazione dell'aria. Non collocare il monitor su tappetini o coperte, né in prossimità di tendaggi che potrebbero bloccare le prese di ventilazione.
- Non installare il monitor vicino a fonti di calore quali radiatori o condotti d'aria calda, né in luoghi esposti alla luce diretta del sole, a polvere eccessiva, a vibrazioni meccaniche o urti.
- Non collocare il monitor accanto ad apparecchi generatori di campi magnetici, quali convertitori o linee ad alta tensione.

#### Manutenzione

- Pulire il rivestimento, il pannello ed i comandi con un panno morbido leggermente inumidito con una soluzione detergente neutra. Non utilizzare alcun tipo di spugna o polvere abrasiva, né solventi quali alcool o benzene.
- Non strofinare, toccare o tamburellare sulla superficie dello schermo con oggetti appuntiti o abrasivi quali penne a sfera o cacciaviti. Ciò potrebbe infatti graffiare il cinescopio a colori.
- Pulire lo schermo con un panno morbido. Se si utilizza un detergente liquido per vetri, assicurarsi che non contenga soluzioni antistatiche o additivi simili, onde evitare di graffiare il rivestimento dello schermo.

#### Trasporto

Se si deve spedire il presente monitor o lo si deve inviare in riparazione, imballarlo nella scatola originale.

### Uso del sistema orientabile

È possibile regolare il monitor entro l'angolazione illustrata qui sotto. Per trovare il centro del raggio di rotazione del monitor, allineare il centro dello schermo del monitor con i punti di centratura del supporto. Per ruotare il monitor verticalmente o orizzontalmente, afferrarlo alla base con entrambe le mani. Quando si inclina verticalmente il monitor, fare attenzione a non schiacciarsi le dita.

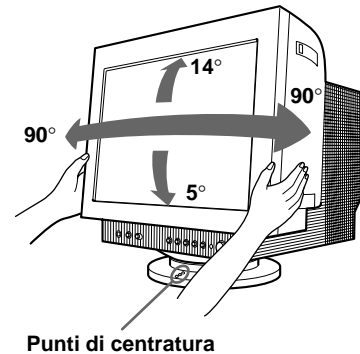

#### Nota

Non rimuovere la base del sistema orientabile dal monitor.

### Avvertenza per i collegamenti di alimentazione

- Usare un cavo di alimentazione adeguato all'alimentazione del paese in cui ci si trova.

#### Esempi di tipi di spina:

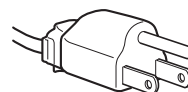

per CA da 100 a  
120 V

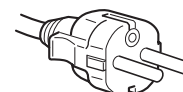

per CA da 200 a  
240 V

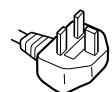

solo per CA 240 V

- Prima di scollegare il cavo di alimentazione, attendere almeno 30 secondi dallo spegnimento dell'apparecchio per consentire la dispersione dell'elettricità statica sulla superficie del tubo catodico.
- Non appena si accende l'apparecchio, il tubo catodico viene smagnetizzato per circa 5 secondi. Questa operazione crea un forte campo magnetico attorno al telaio metallico, che potrebbe danneggiare i dati di dischi o nastri magnetici situati nelle immediate vicinanze. Collocare eventuali apparecchiature di registrazione e dischi o nastri lontano dal monitor.

L'apparecchiatura dovrebbe essere situata in prossimità di una presa di rete facilmente accessibile.

## Identificazione dei componenti e dei comandi

Per maggiori dettagli consultare le pagine indicate tra parentesi.

### Parte anteriore

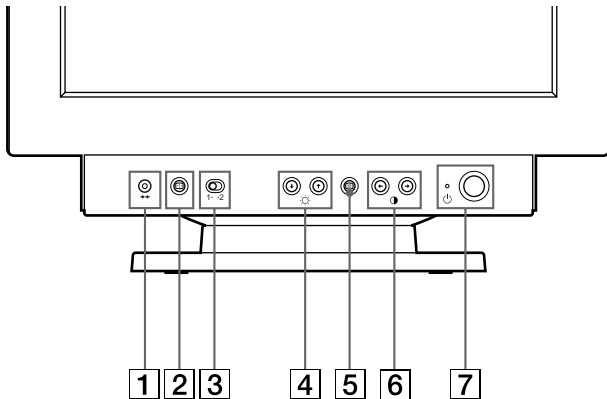

- 1 Tasto <math>\leftarrow\rightarrow</math> (ripristina) (pagina 15)**  
Per ripristinare le impostazioni effettuate in fabbrica.
- 2 Tasto <math>\oplus</math> (ridimensionamento e centratura automatici) (pagina 5)**  
Utilizzare questo tasto per regolare automaticamente le dimensioni e la centratura dell'immagine.
- 3 Interruttore INPUT 1-2 (ingresso) (pagina 5)**  
Utilizzare questo interruttore per selezionare l'ingresso INPUT 1 (connettore 1 d'ingresso video) o INPUT 2 (connettore 2 d'ingresso video)
- 4 Tasti <math>\downarrow/\uparrow</math> <math>\odot</math> (luminosità) (pagine 6-15)**  
Per regolare la luminosità dell'immagine.  
  
Svolgono la stessa funzione dei tasti <math>\downarrow/\uparrow</math> per la regolazione di altre voci.
- 5 Tasto <math>\boxminus</math> (menu) (pagine 6-15, 17)**  
Per visualizzare l'indicazione a schermo MENU.
- 6 Tasti <math>\leftarrow/\rightarrow</math> <math>\odot</math> (contrasto) (pagine 6-15, 20)**  
Per regolare il contrasto.  
  
Svolgono la stessa funzione dei tasti <math>\leftarrow/\rightarrow</math> per la regolazione di altre voci.
- 7 Interruttore ed indicatore di accensione <math>\odot</math> (pagine 16, 20)**  
Per accendere e spegnere il monitor.  
Quando il monitor viene acceso, l'indicatore di accensione si illumina in verde; quando il monitor entra nel modo di risparmio energetico, l'indicatore lampeggia in arancione e in verde in modo alternato o si illumina in arancione.

### Parte posteriore

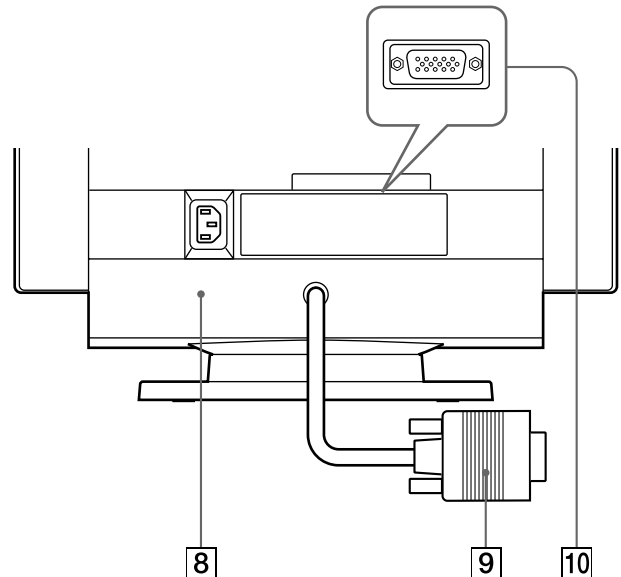

- 8 Connettore AC IN (pagina 4)**  
Collega un cavo di alimentazione CA al monitor.
- 9 Connettore 1 di ingresso video (HD15) (pagina 4)**  
Immette segnali video RGB (0,700 Vp-p, positivo) e segnali SYNC.

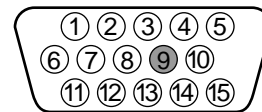

N. piedino	Segnale	N. piedino	Segnale
1	Rosso	9	—
2	Verde (Sincronismo su verde)	10	Terra
		11	ID (Terra)
3	Blu	12	Dati bidirezionali (SDA)*
4	ID (Terra)		
5	Terra DDC*	13	Sinc O.
6	Terra rosso	14	Sinc V.
7	Terra verde	15	Orologio dati (SCL)*
8	Terra blu		

\* Standard del Display Data Channel (DDC) del marchio VESA

- 10 Connettore 2 di ingresso video (HD15) (pagina 4)**  
Immette segnali video RGB (0,700 Vp-p, positivo) e segnali SYNC.  
Per l'assegnazione dei piedini, vedere la tabella sopra indicata.

### Installazione

Questo monitor si sincronizza perfettamente con piattaforme funzionanti su frequenze orizzontali tra 30 e 107 kHz.

#### Punto 1: Controllare che il computer e il monitor siano spenti

#### Punto 2: Collegare il monitor al computer

Collegare il cavo del segnale video all'uscita video del computer.

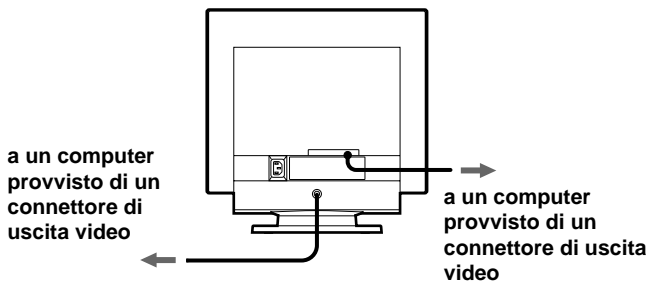

#### Nota

Non accorciare i piedini del cavo del segnale video.

#### Punto 3: Collegare il cavo di alimentazione

Con il monitor spento, collegare un capo del cavo di alimentazione appropriato per la rete elettrica locale al monitor e l'altro capo alla presa di rete.

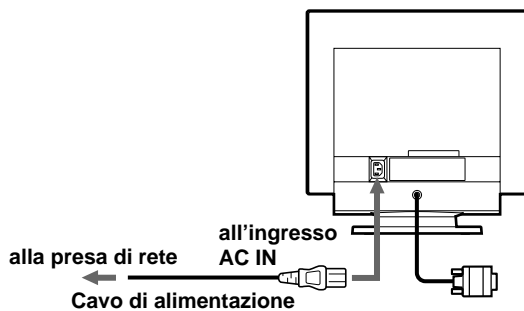

#### Punto 4: Accendere il monitor ed il computer

#### Punto 5: Regolare i comandi del monitor come desiderato

L'installazione del monitor è completata.

#### Nota

Se sullo schermo non appare nessuna immagine ma appare "FUORI GAMMA SCANS" o "IL MONITOR È IN MODO RISPARMIO ENERGETICO", vedere la sezione "Messaggi di avvertimento" a pagina 17.

#### Preparazione della postazione di lavoro

##### Collocazione del monitor

Non collocare il monitor in prossimità di lampade fluorescenti o di altri apparecchi in grado di generare campi magnetici, onde evitare eventuali interferenze. Assicurarsi che la base su cui viene appoggiato il monitor sia in grado di reggerne il peso. Lasciare uno spazio libero di almeno 50 mm intorno al monitor.

##### Altezza

Collocare il monitor in modo che, quando si è seduti di fronte ad esso, il bordo superiore dello schermo sia leggermente inferiore al livello degli occhi.

##### Orientamento

Collocare il monitor in modo che il riflesso provocato da sorgenti luminose sia minimo, ad esempio ad angolo retto con le finestre. Collocare il monitor esattamente di fronte alla propria posizione di lavoro. Ruotare il monitor in modo da ottenere l'angolazione migliore.

#### Consigli e precauzioni per il lavoro al computer

##### Pause

Fare pause ad intervalli regolari. Non assumere la stessa posizione per periodi di tempo prolungati, alzarsi e sciogliere i muscoli periodicamente onde evitare un eccessivo affaticamento.

##### Schiena

Sedersi in modo che la schiena sia completamente appoggiata allo schienale.

##### Mani

Premere i tasti della tastiera in modo leggero, mantenendo le mani e le dita rilassate. Assicurarsi di avere sufficiente spazio di fronte alla tastiera in modo da riposare i polsi quando non si utilizza la tastiera. Se possibile, utilizzare un appoggiapolsi.

##### Vista

Lavorare con i monitor può affaticare la vista. Distogliere lo sguardo dal monitor ad intervalli regolari e sottoporsi periodicamente a controlli specialistici.

##### Impostazione dello schermo

Regolare correttamente la luminosità e il contrasto. Può essere necessario modificare tali regolazioni durante il corso della giornata in base alla diversa luminosità. Molte applicazioni consentono di selezionare tra diverse combinazioni di colore quella più adatta.

## Selezione del segnale di ingresso

Se si utilizzano il connettore di ingresso video 1 e il connettore di ingresso video 2, è possibile collegare due computer a questo monitor. Per selezionare uno dei due computer, utilizzare l'interruttore INPUT 1-2.

Spostare l'interruttore INPUT 1-2.

Il connettore selezionato appare sullo schermo per 3 secondi.





“INPUT 1” (connettore 1 di ingresso video) o “INPUT 2” (connettore 2 di ingresso video) appare sullo schermo.

### Nota

Se non arriva nessun segnale al connettore selezionato, sullo schermo appare il messaggio NO SEGNALE INGRESSO e dopo alcuni secondi il monitor entra nel modo di risparmio energetico. In questo caso, selezionare l'altro connettore.

## Redimensionamento e centratura automatici dell'immagine

È possibile regolare l'immagine in modo che venga visualizzata sullo schermo intero in modo facile premendo il tasto  (ridimensionamento e centratura automatici).

Premere il tasto .

L'immagine viene visualizzata automaticamente sullo schermo intero.

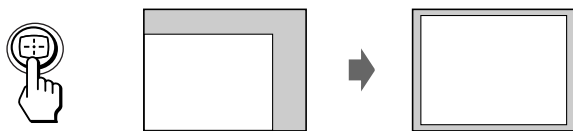

### Note

- Utilizzare questa funzione con computer su cui è possibile visualizzare le immagini con le stesse dimensioni dello schermo. Questa funzione potrebbe non funzionare correttamente se il colore di sfondo è scuro o se l'immagine di ingresso non riempie lo schermo fino ai bordi.
- Le immagini con rapporto di formato di 5:4 (risoluzione: 1280 × 1024) vengono visualizzate nella loro risoluzione reale senza riempire lo schermo fino ai bordi.
- Quando viene premuto il tasto , l'immagine visualizzata si muove per alcuni secondi. Non si tratta di un guasto al monitor.

Operazioni precedenti la regolazione

- Collegare il monitor e il computer e poi accenderli.

## Selezione della lingua per l'indicazione a schermo (OSD)

Nel caso in cui occorra cambiare la lingua dell'OSD, consultare "Uso dell'indicazione a schermo LANGUAGE" a pagina 11.

La lingua inglese è la lingua preimpostata.

## Regolazione della luminosità e del contrasto dell'immagine

Dopo aver regolato l'impostazione, questa viene memorizzata per tutti i segnali in entrata ricevuti.

- 1 Premere i tasti ☀ (luminosità) ↓/↑ o ● (contrasto) ←/→.

Appare l'indicazione a schermo LUMINOSITA'/CONTRASTO.

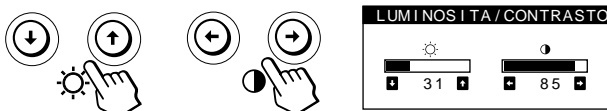

- 2 Per la regolazione della luminosità Premere i tasti ☀ ↓/↑.

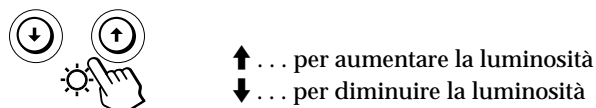

Per la regolazione del contrasto Premere i tasti ● ←/→.

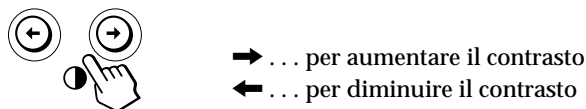

L'indicazione a schermo scompare automaticamente dopo circa 3 secondi.

Per reimpostare i valori, premere il tasto ↶ (ripristina) mentre l'indicazione a schermo è attiva. Vengono ristabiliti i valori preimpostati in fabbrica della luminosità e del contrasto.

Se nell'impostazione del colore viene selezionato sRGB "SI", la luminosità (☀) e il contrasto (●) vengono impostati automaticamente su "31" e su "85".

Per ulteriori informazioni su sRGB, si veda la sezione "Uso dell'indicazione a schermo COLORE" a pagina 9.

## Il sistema di indicazione a schermo

La maggior parte delle regolazioni vengono effettuate usando il sistema di indicazione a schermo MENU.

### Indicazione a schermo MENU

Per visualizzare l'indicazione a schermo MENU premere il tasto ☰.

Nell'indicazione a schermo MENU sono inclusi dei collegamenti ad altre indicazioni a schermo descritte di seguito.

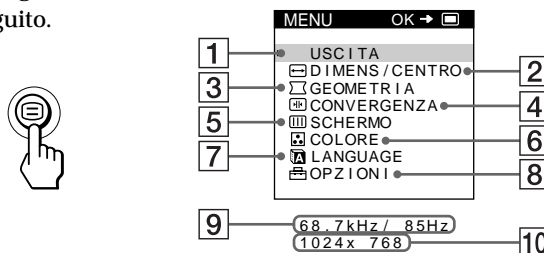

- 1 **USCITA**  
Chiude l'indicazione a schermo MENU.
- 2 **DIMENS/CENTRO**  
Visualizza l'indicazione a schermo DIMENS/CENTRO per regolare le dimensioni, la centratura e l'ingrandimento o la riduzione dell'immagine.
- 3 **GEOMETRIA**  
Visualizza l'indicazione a schermo GEOMETRIA per regolare la rotazione e la distorsione a cuscino dell'immagine, ecc.
- 4 **COLORE**  
Visualizza l'indicazione a schermo COLORE per regolare la temperatura di colore.
- 5 **CONVERGENZA**  
Visualizza l'indicazione a schermo CONVERGENZA per regolare la convergenza verticale e orizzontale dell'immagine.
- 6 **LANGUAGE**  
Visualizza l'indicazione a schermo LANGUAGE per selezionare la lingua.
- 7 **OPZIONI**  
Visualizza l'indicazione a schermo OPZIONI per regolare la posizione dell'OSD e per smagnetizzare lo schermo, ecc.
- 8 **GUIDA**  
Visualizza l'indicazione a schermo GUIDA per la visualizzazione di informazioni e suggerimenti utili relativi al monitor.
- 9 **Frequenze verticali e orizzontali del segnale d'ingresso corrente**  
Vengono visualizzate le frequenze verticali e orizzontali del segnale d'ingresso corrente.
- 10 **Risoluzione del segnale d'ingresso corrente**  
Se il segnale corrisponde ad uno dei modi del monitor preimpostati in fabbrica, la risoluzione viene visualizzata.

## Uso dell'indicazione a schermo DIMENS/CENTRO

Grazie alle impostazioni di DIMENS/CENTRO è possibile regolare le dimensioni, la centratura e l'ingrandimento o la riduzione dell'immagine.

I dati della regolazione verranno preimpostati in memoria per il segnale di ingresso corrente.

### 1 Premere il tasto .

Appare l'indicazione a schermo MENU.







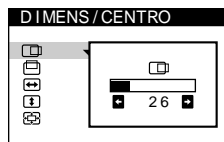
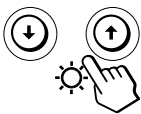

### 2 Premere i tasti / per selezionare "DIMENS/CENTRO", quindi premere di nuovo il tasto .

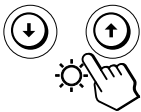
Appare l'indicazione a schermo DIMENS/CENTRO









### 3 Premere i tasti / per selezionare la voce per cui si desidera effettuare la regolazione.

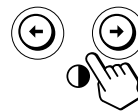



Selezionare	Per
 (Centratura orizzontale)	regolare la centratura orizzontale dell'immagine
 (Centratura verticale)	regolare la centratura verticale dell'immagine
 (Ridimensionamento orizzontale)	regolare le dimensioni orizzontali dell'immagine
 (Ridimensionamento verticale)	regolare le dimensioni verticali dell'immagine
 (Ingrandimento/riduzione)	ingrandire o ridurre l'immagine

### 4 Premere i tasti / per regolare le impostazioni.



Selezionare	Per
 (Centratura orizzontale)	➔ ... spostare verso destra l'immagine ➤ ... spostare verso sinistra l'immagine
 (Centratura verticale)	➔ ... spostare verso l'alto l'immagine ➤ ... spostare verso il basso l'immagine
 (Ridimensionamento orizzontale)	➔ ... aumentare la larghezza dell'immagine ➤ ... diminuire la larghezza dell'immagine
 (Ridimensionamento verticale)	➔ ... aumentare l'altezza dell'immagine ➤ ... diminuire l'altezza dell'immagine
 (Ingrandimento/riduzione)	➔ ... ingrandire l'immagine ➤ ... ridurre l'immagine

Premere una volta il tasto  per tornare all'indicazione a schermo MENU, premerlo due volte per tornare alla visualizzazione normale. Se non viene premuto alcun tasto, l'indicazione a schermo MENU si chiude automaticamente dopo circa 30 secondi.

Per reimpostare i valori, premere il tasto  (ripristina) mentre l'indicazione a schermo è attiva.

Vengono ristabiliti i valori preimpostati in fabbrica per le voci selezionate.

#### Nota

La regolazione di  (Ingrandimento/riduzione) si arresta quando le dimensioni orizzontali o verticali raggiungono il valore massimo o minimo. Il valore della regolazione orizzontale non viene visualizzato nel menu.

## Uso dell'indicazione a schermo GEOMETRIA

Le impostazioni di GEOMETRIA consentono la regolazione della forma e dell'orientamento dell'immagine.



Una volta che  (Rotazione) è stato regolato, verrà inserito nella memoria per tutti i segnali d'ingresso ricevuti. Gli altri dati verranno memorizzati per il segnale di ingresso corrente.

### 1 Premere il tasto .

Appare l'indicazione a schermo MENU.



### 2 Premere i tasti / per selezionare



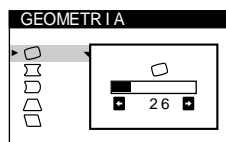
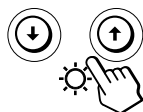

" GEOMETRIA", quindi premere di nuovo il tasto .

Appare l'indicazione a schermo GEOMETRIA.

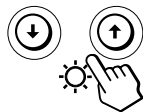









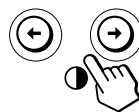

















### 3 Premere i tasti / per selezionare la voce per cui si desidera effettuare la regolazione.





Selezionare	Per
 (Rotazione)	effettuare la regolazione della rotazione dell'immagine
 (Regolazione lati)	effettuare la regolazione dei lati dell'immagine
 (Bilanciamento lati)	effettuare la regolazione del bilanciamento dell'immagine ai lati
 (Regolazione ampiezza)	effettuare la regolazione dell'ampiezza dell'immagine
 (Bilanciamento forma)	effettuare la regolazione del bilanciamento della forma dell'immagine

### 4 Premere i tasti / per regolare le impostazioni.



Per	Premere
 (Rotazione)	<p> ... per ruotare l'immagine in senso orario</p> <p></p> <p> ... per ruotare l'immagine in senso antiorario</p> <p></p>
 (Regolazione lati)	<p> ... per espandere i bordi dell'immagine</p> <p></p> <p> ... per contrarre i bordi dell'immagine</p> <p></p>
 (Bilanciamento lati)	<p> ... per espandere i bordi dell'immagine verso destra</p> <p></p> <p> ... per espandere i bordi dell'immagine verso sinistra</p> <p></p>
 (Regolazione ampiezza)	<p> ... per aumentare l'ampiezza del bordo superiore dell'immagine</p> <p></p> <p> ... per diminuire l'ampiezza del bordo superiore dell'immagine</p> <p></p>
 (Bilanciamento forma)	<p> ... per spostare a destra il bordo superiore dell'immagine</p> <p></p> <p> ... per spostare a sinistra il bordo superiore dell'immagine</p> <p></p>

Premere una volta il tasto  per tornare all'indicazione a schermo MENU, premerlo due volte per tornare alla visualizzazione normale. Se non viene premuto alcun tasto, l'indicazione a schermo MENU si chiude automaticamente dopo circa 30 secondi.

Per reimpostare il valore, premere il tasto  (ripristina) mentre l'indicazione a schermo è attiva.

Viene ristabilito il valore preimpostato in fabbrica per le voci selezionate.







## Uso dell'indicazione a schermo COLORE

È possibile modificare la temperatura di colore del monitor. Per esempio, è possibile cambiare i colori di un'immagine sullo schermo in modo da abbinarli ai colori reali dell'immagine stampata.



I dati della regolazione verranno memorizzati per tutti i segnali di ingresso ricevuti.

- 1 Premere il tasto .  
Appare l'indicazione a schermo MENU.

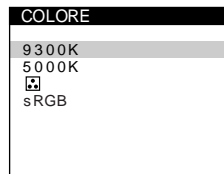
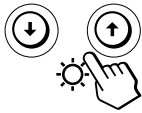

- 2 Premere i tasti / per selezionare "  COLORE", quindi premere di nuovo il tasto .  
Appare l'indicazione a schermo COLORE.





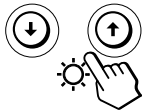

- 3 Premere i tasti / per selezionare la temperatura del colore.



Vi sono due modi di temperatura del colore nell'indicazione a schermo.  
La regolazione predefinita è 9.300 K.

Selezionare la propria temperatura del colore tra 9.300K e 5.000K

Premere i tasti / per selezionare "  (Variabile)" ed effettuare la regolazione premendo i tasti /.

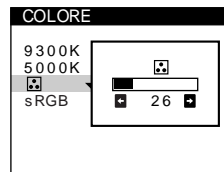
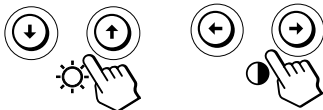

- ➔ ... per una maggiore temperatura (blu)
- ➔ ... per una minore temperatura (rosso)



Premere una volta il tasto  per tornare all'indicazione a schermo MENU, premerlo due volte per tornare alla visualizzazione normale. Se non viene premuto alcun tasto, l'indicazione a schermo MENU si chiude automaticamente dopo circa 30 secondi.



Per reimpostare il valore, premere il tasto  (ripristina) mentre l'indicazione a schermo è attiva. Viene ripristinato il valore preimpostato in fabbrica della temperatura di colore.



## Modo sRGB

L'impostazione del colore sRGB è un protocollo standard industriale della spaziatura del colore progettato per far corrispondere i colori visualizzati e quelli stampati dai computer conformi a sRGB. Per regolare i colori sul profilo sRGB, è sufficiente selezionare sRGB "SI" nel menu COLORE.

Tuttavia, per visualizzare correttamente i colori sRGB ( $\gamma = 2,2$ , 6500K), è necessario impostare il computer sul profilo sRGB.

Se si seleziona sRGB "SI", la luminosità () e il contrasto () vengono impostati automaticamente su "31" e su "85".

Se si modificano la luminosità () e il contrasto () , l'impostazione sRGB viene disattivata.

Per ulteriori informazioni sulla modifica della luminosità () e del contrasto () , vedere a pagina 6.

## Nota

Il computer e gli altri prodotti collegati (ad esempio una stampante) devono essere conformi a sRGB.

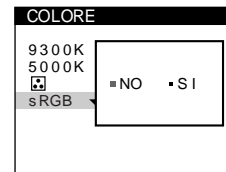

## Uso dell'indicazione a schermo CONVERGENZA





Le impostazioni del menu CONVERGENZA consentono di regolare la qualità dell'immagine tramite il controllo della convergenza. La convergenza riguarda l'allineamento dei segnali dei colori rosso, verde e blu.

Se vengono visualizzate ombre rosse o blu attorno ai caratteri o alle linee, regolare la convergenza.



I dati della regolazione verranno memorizzati per tutti i segnali di ingresso ricevuti.

- 1 Premere il tasto .  
Appare l'indicazione a schermo MENU.



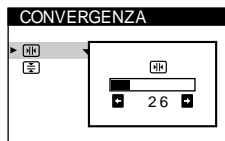
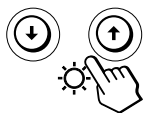

- 2 Premere i tasti / per selezionare "  CONVERGENZA", quindi premere di nuovo il tasto .  
Appare l'indicazione a schermo CONVERGENZA.



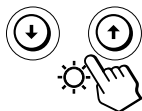



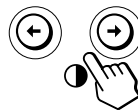

- 3 Premere i tasti / per selezionare la voce per cui si desidera effettuare la regolazione.





- 4 Premere i tasti / per effettuare la regolazione delle impostazioni.



Per	Premere
 (Convergenza orizzontale)	<p> ... per spostare a destra le ombre del rosso ed a sinistra le ombre del blu</p> <p> ... per spostare a sinistra le ombre del rosso ed a destra le ombre del blu</p>
 (Convergenza verticale)	<p> ... per spostare in alto le ombre del rosso ed in basso le ombre del blu</p> <p> ... per spostare in basso le ombre del rosso ed in alto le ombre del blu</p>

Premere una volta il tasto  per tornare all'indicazione a schermo MENU, premerlo due volte per tornare alla visualizzazione normale. Se non viene premuto alcun tasto, l'indicazione a schermo MENU si chiude automaticamente dopo circa 30 secondi.

Per reimpostare il valore, premere il tasto  (ripristina) mentre l'indicazione a schermo è attiva. Per la voce selezionata viene ristabilito il valore preimpostato in fabbrica.





Selezionare	Per
 (Convergenza orizzontale)	effettuare la regolazione della convergenza orizzontale
 (Convergenza verticale)	effettuare la regolazione della convergenza verticale

## Uso dell'indicazione a schermo LANGUAGE



Le indicazioni a schermo possono essere visualizzate in inglese, francese, tedesco, spagnolo, italiano, olandese, svedese, russo e giapponese.

- 1 Premere il tasto .  
Appare l'indicazione a schermo MENU.



- 2 Premere i tasti / per selezionare "  LANGUAGE", quindi premere di nuovo il tasto .  
Appare l'indicazione a schermo LANGUAGE.



- 3 Premere i tasti / per selezionare la lingua desiderata.

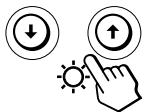

- ENGLISH: Inglese
- FRANÇAIS: Francese
- DEUTSCH: Tedesco
- ESPAÑOL: Spagnolo
- ITALIANO
- NEDERLANDS: Olandese
- SVENSKA: Svedese
- РУССКИЙ: Russo
- 日本語: Giapponese

Premere una volta il tasto  per tornare all'indicazione a schermo MENU, premerlo due volte per tornare alla visualizzazione normale. Se non viene premuto alcun tasto, l'indicazione a schermo MENU si chiude automaticamente dopo circa 30 secondi.

Per reimpostare la lingua inglese, premere il tasto  (ripristina) mentre l'indicazione a schermo è attiva.

## Uso dell'indicazione a schermo OPZIONI





Grazie all'indicazione a schermo OPZIONI è possibile smagnetizzare lo schermo, regolare il livello di eliminazione dell'effetto moiré e regolare la posizione delle indicazioni a schermo manualmente. Consente inoltre di bloccare i comandi.

### Smagnetizzazione dello schermo



Lo schermo del monitor viene smagnetizzato automaticamente con l'attivazione dell'alimentazione. È possibile effettuare anche manualmente la smagnetizzazione dello schermo.

- 1 Premere il tasto .  
Appare l'indicazione a schermo MENU.

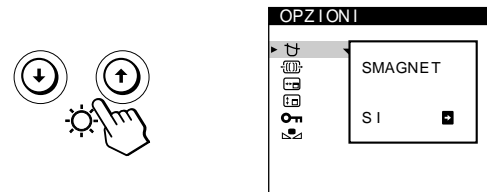

- 2 Premere i tasti / per selezionare "  OPZIONI", quindi premere di nuovo il tasto .  
Appare l'indicazione a schermo OPZIONI.



- 3 Premere i tasti / per selezionare "  (SMAGNET)".

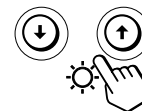

- 4 Premere il tasto .  
Lo schermo si smagnetizza per circa 5 secondi.



Nel caso in cui sia necessario smagnetizzare una seconda volta lo schermo, attendere almeno 20 minuti prima di ripetere la procedura sopra indicata.





Premere una volta il tasto  per tornare all'indicazione a schermo MENU, premerlo due volte per tornare alla visualizzazione normale. Se non viene premuto alcun tasto, l'indicazione a schermo MENU si chiude automaticamente dopo circa 30 secondi.

## Regolazione dell'effetto moiré



Se sullo schermo appaiono motivi ellittici o ondulati, regolare il livello di eliminazione dell'effetto moiré.

- 1 Premere il tasto .  
Appare l'indicazione a schermo MENU.



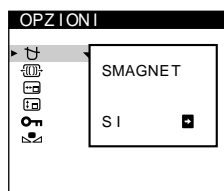
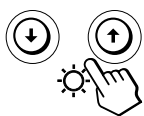

- 2 Premere i tasti / per selezionare "  OPZIONI", quindi premere di nuovo il tasto .  
Appare l'indicazione a schermo OPZIONI.

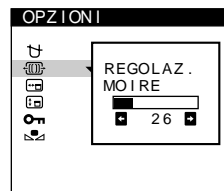
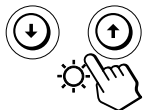

- 3 Premere i tasti / per selezionare "  REGOLAZ MOIRE\*".



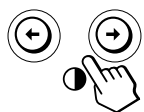

- 4 Premere i tasti / per regolare il livello di eliminazione dell'effetto moiré finché non raggiunge il valore minimo.

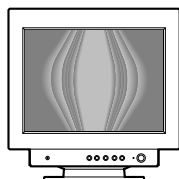

\* L'effetto moiré è un tipo di interferenza naturale che produce linee leggere e ondulate sullo schermo. Questo si verifica a causa dell'interferenza tra il motivo dell'immagine sullo schermo e il motivo a punti di fosforo del tubo a raggi catodici.

Esempio di effetto moiré:



Premere una volta il tasto  per tornare all'indicazione a schermo MENU, premerlo due volte per tornare alla visualizzazione normale. Se non viene premuto alcun tasto, l'indicazione a schermo MENU si chiude automaticamente dopo circa 30 secondi.





Per reimpostare i valori, premere il tasto  (ripristina) mentre l'indicazione a schermo è visualizzata.

## Modifica della posizione dell'indicazione a schermo





È possibile modificare la posizione dell'indicazione a schermo (per esempio, nel caso in cui si desideri effettuare la regolazione dell'immagine dietro l'indicazione stessa).

- 1 Premere il tasto .  
Appare l'indicazione a schermo MENU.

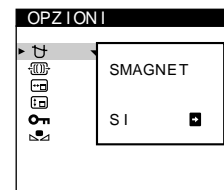
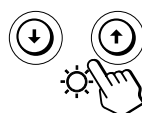

- 2 Premere i tasti / per selezionare "  OPZIONI", quindi premere di nuovo il tasto .  
Appare l'indicazione a schermo OPZIONI.



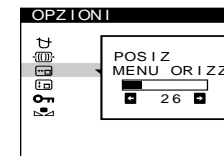
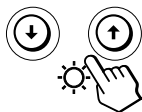

- 3 Premere i tasti / per selezionare "  (POSIZ MENU ORIZZ)" o "  (POSIZ MENU VERT)".  
Selezionare "  (POSIZ MENU ORIZZ)" per effettuare la regolazione della posizione orizzontale.



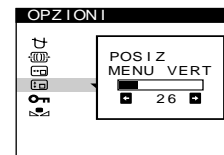
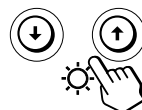

Selezionare "  (POSIZ MENU VERT)" per effettuare la regolazione della posizione verticale.

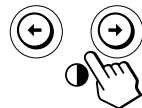

- 4 Premere i tasti / per spostare l'indicazione a schermo nella posizione desiderata.



Premere una volta il tasto  per tornare all'indicazione a schermo MENU, premerlo due volte per tornare alla visualizzazione normale. Se non viene premuto alcun tasto, l'indicazione a schermo MENU si chiude automaticamente dopo circa 30 secondi.





Per reimpostare i valori, premere il tasto  (ripristina) mentre l'indicazione a schermo è attiva.

## Funzione di bloccaggio dei comandi



È possibile proteggere le regolazioni effettuate bloccando i comandi.

- 1 Premere il tasto .  
Appare l'indicazione a schermo MENU.

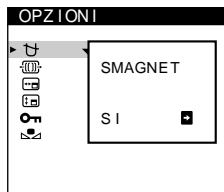
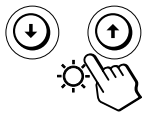

- 2 Premere i tasti / per selezionare "  OPZIONI", quindi premere di nuovo il tasto .  
Appare l'indicazione a schermo OPZIONI.





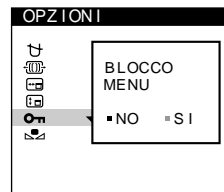
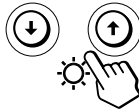

- 3 Premere i tasti / per selezionare "  (BLOCCO MENU)".

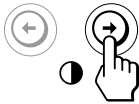

- 4 Premere il tasto  per selezionare "SI".



Premere una volta il tasto  per tornare all'indicazione a schermo MENU, premerlo due volte per tornare alla visualizzazione normale. Se non viene premuto alcun tasto, l'indicazione a schermo MENU si chiude automaticamente dopo circa 30 secondi.

Soltanto l'interruttore  (accensione) e i tasti USCITA e "  (BLOCCO MENU)" dell'indicazione a schermo "  OPZIONI" non vengono disabilitati. Se viene selezionata qualsiasi altra voce, sullo schermo appare il contrassegno .

### Per eliminare il bloccaggio dei comandi





Ripetere le procedure che vanno dal punto 1 al punto 3 descritte sopra e premere il tasto  per selezionare "NO".

## Ripristino del colore



Dopo molti anni di utilizzo, nella maggior parte dei monitor il colore tende a perdere gradualmente luminosità. La funzione RIPRISTINO COLORE permette di ripristinare il colore ai livelli di qualità originali. Le indicazioni che seguono spiegano come ripristinare il colore del monitor.

- 1 Premere il tasto .  
Appare l'indicazione a schermo MENU.

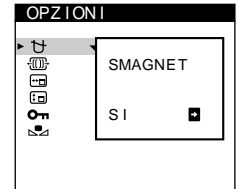
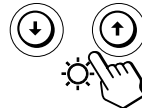

- 2 Premere i tasti / per selezionare "  OPZIONI", quindi premere di nuovo il tasto .  
Appare l'indicazione a schermo OPZIONI.



- 3 Premere i tasti / per selezionare "  (RIPRISTINO COLORE)".

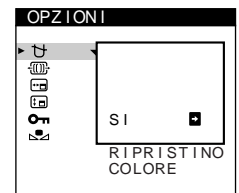
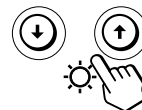

- 4 Premere il tasto  per selezionare "SI".



Mentre il colore viene ripristinato (2 secondi circa), l'immagine scompare. Una volta terminato il ripristino del colore, l'immagine appare di nuovo sullo schermo.

Premere una volta il tasto  per tornare all'indicazione a schermo MENU, premerlo due volte per tornare alla visualizzazione normale. Se non viene premuto alcun tasto, l'indicazione a schermo MENU si chiude automaticamente dopo circa 30 secondi.

### Note

- Per utilizzare questa funzione, il monitor deve essere nel modo di funzionamento normale (indicatore di accensione illuminato in verde) per almeno 30 minuti. Se il monitor entra nel modo di risparmio energetico, è necessario farlo tornare al modo di funzionamento normale e attendere per 30 minuti che sia pronto. Per mantenere il monitor nel modo di funzionamento normale per tutti i 30 minuti, potrebbe essere necessario regolare le impostazioni del modo di risparmio energetico del computer. Se il monitor non è pronto, sullo schermo appare il seguente messaggio.

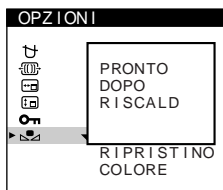



- Il monitor potrebbe perdere gradualmente la capacità di eseguire questa funzione a causa dell'usura del cinescopio a colori.

## Utilizzo dell'indicazione a schermo GUIDA ?



Il menu GUIDA contiene informazioni e suggerimenti utili relativi a questo monitor. Se sul monitor vengono visualizzati sintomi corrispondenti a quelli elencati nel menu GUIDA, seguire le istruzioni a schermo per risolvere il problema. Se i sintomi non corrispondono a quelli elencati nel menu GUIDA o se il problema persiste, vedere la sezione "Guida alla soluzione dei problemi" a pagina 18.

- 1 Premere il tasto .  
Appare l'indicazione a schermo MENU.

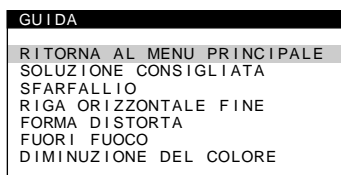
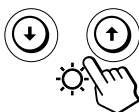

- 2 Premere i tasti / per selezionare " ? GUIDA", quindi premere di nuovo il tasto .  
Appare l'indicazione a schermo GUIDA.



- 3 Premere i tasti / per selezionare una voce del menu GUIDA.  
Sullo schermo appaiono le istruzioni o le informazioni relative alla soluzione del problema. Qui di seguito viene fornita la spiegazione di ogni voce del menu.

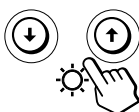

### SOLUZIONE CONSIGLIATA

Se l'immagine non riempie lo schermo fino ai bordi o se è più grande dello schermo, regolare la risoluzione sui valori indicati nel menu utilizzando il proprio computer. Se il segnale di ingresso corrisponde ad uno dei modi preimpostati in fabbrica di questo monitor, verranno visualizzate la risoluzione e la frequenza di refresh del segnale di ingresso corrente.

### SFARFALLIO

Se nell'immagine si verifica uno sfarfallio, regolare la frequenza di refresh sui valori indicati nel menu. Se il segnale di ingresso corrisponde ad uno dei modi preimpostati in fabbrica di questo monitor, verrà visualizzata la frequenza di refresh del segnale di ingresso corrente.

### RIGA ORIZZONTALE FINE

Le linee che appaiono sullo schermo sono i cavi di smorzamento. Vedere a pagina 16 per maggiori informazioni sui cavi di smorzamento.



### FORMA DISTORTA

Se l'immagine sullo schermo appare distorta, provare a regolarne la geometria. Premere il tasto  per passare direttamente all'indicazione a schermo GEOMETRIA.

### FUORI FUOCO

L'immagine potrebbe apparire fuori fuoco quando i segnali di colore rosso e blu non sono correttamente allineati in modo da causare delle ombre rosse o blu intorno alle lettere e alle linee. Provare a regolare la convergenza dell'immagine per far scomparire le ombre. Premere il tasto  per passare direttamente all'indicazione a schermo CONVERGENZA. Quando viene visualizzato il menu CONVERGENZA, le impostazioni relative alla regolazione del contrasto, della luminosità e dell'effetto moiré vengono reimpostate automaticamente per tutti i segnali di ingresso.





### DIMINUZIONE DEL COLORE

Se in alcune parti dello schermo il colore dell'immagine appare anomalo, controllare per prima cosa che i cavi del segnale siano saldamente collegati. Dopo aver controllato i cavi, provare a smagnetizzare manualmente lo schermo. Premere il tasto  per passare direttamente all'indicazione a schermo OPZIONI, quindi selezionare  (SMAGNET).



Premere una volta il tasto  per tornare all'indicazione a schermo MENU, premerlo due volte per tornare alla visualizzazione normale. Se non viene premuto alcun tasto, l'indicazione a schermo MENU si chiude automaticamente dopo circa 30 secondi.

## Reimpostazione dei dati di regolazione

### Reimpostazione dei dati di una regolazione

- 1 Premere i tasti  e /  per selezionare l'indicazione a schermo contenente la voce che si desidera reimpostare, quindi premere di nuovo il tasto .



- 2 Premere i tasti /  per selezionare la voce di cui si desidera reimpostare il valore.

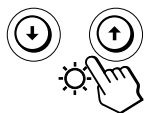

- 3 Premere il tasto  (ripristina).

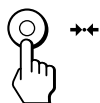

### Reimpostazione di tutti i dati della regolazione per il segnale di ingresso corrente

Nel caso in cui non sia visualizzata alcuna indicazione a schermo, premere il tasto  (ripristina).

Sono ripristinati tutti i valori preimpostati in fabbrica per il segnale di ingresso corrente.

Si noti che la reimpostazione del segnale corrente non ha alcun effetto sulla luminosità e il contrasto, sulla lingua per le indicazioni a schermo, sulla posizione delle indicazioni a schermo né sul bloccaggio dei comandi.

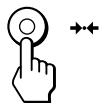



### Reimpostazione di tutti i dati della regolazione per tutti i segnali di ingresso

Premere e tenere premuto il tasto  (ripristina) per oltre due secondi.

Vengono ristabiliti tutti i dati di regolazione preimpostati in fabbrica, inclusi quelli della luminosità e del contrasto.



#### Nota

Il tasto  (ripristina) non è attivo quando  (BLOCCO MENU) è impostato su SI.

### Funzione di risparmio energetico

Questo monitor è conforme alle direttive sul risparmio energetico della VESA e di ENERGY STAR, così come della più severa NUTEK.

Nel caso in cui il monitor fosse collegato ad un computer o ad una scheda grafica video conformi a VESA DPMS (Display Power Management Signaling), il monitor ridurrà automaticamente il consumo energetico in tre stadi come illustrato qui sotto.

#### Note

- Se si preme un qualsiasi tasto sul monitor mentre il computer si trova nel modo di risparmio energetico, sullo schermo appare “IL MONITOR È IN MODO RISPARMIO ENERGETICO” (pagina 17). Dopo pochi secondi il monitor entra di nuovo nel modo di risparmio energetico. Una volta che i segnali di sincronizzazione orizzontale e verticale vengono rilevati, il monitor torna automaticamente al modo operativo normale.
- La funzione per il controllo del consumo energetico viene attivata quando non si utilizza il mouse o la tastiera per un determinato periodo di tempo definito dall'utente.
- La IBM consiglia di spegnere il monitor alla fine della giornata di lavoro o se si prevede di non utilizzarlo per molte ore durante la stessa sessione di lavoro.

	Modo di consumo energetico	Schermo	Segnale di sincronizzazione orizzontale	Segnale di sincronizzazione verticale	Consumo energetico	Tempo di recupero	Indicatore 
1	Funzionamento normale	attivo	presente	presente	≤ 140 W	—	Verde
2	Attesa (I modo)	vuoto	assente	presente	≤ 15 W	5 sec. circa	Verde ed arancio alternato
3	Sospeso (II modo) (sleep)*	vuoto	presente	assente	≤ 15 W	5 sec. circa	Verde ed arancio alternato
4	Attivo-spegnito (III modo) (deep sleep)*	vuoto	assente	assente	≤ 3 W	15 sec. circa	Arancio
5	Spento	—	—	—	≤ 0,5 W	—	Spento

\* “Sleep” e “deep sleep” sono modalità di risparmio energetico definite dalla Environmental Protection Agency.

### Cavi di smorzamento

Quando si utilizza uno sfondo bianco, sullo schermo potrebbero essere visibili delle righe orizzontali molto sottili. Queste righe sono l'ombra dei cavi di smorzamento, caratteristiche dei tubi a raggi catodici che utilizzano le griglie di apertura. I cavi sono collegati alla griglia di apertura all'interno del tubo Trinitron e servono a prevenire le vibrazioni della griglia di apertura.

Cavi di smorzamento

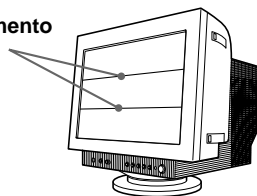

### Uso immediato

Questo monitor è conforme agli standard Display Data Channel (DDC) DDC1, DDC2B e DDC2Bi di VESA.

Quando è collegato un sistema ospite DDC1, il monitor si sincronizza con il V. CLK secondo gli standard VESA ed emette dati EDID (Extended Display Identification Data) nella linea dati.

Quando è collegato un sistema ospite DDC2B o DDC2Bi, il monitor passa automaticamente allo standard appropriato.



### Modi preimpostati

N.	Risoluzione (punti× righe)	Frequenza orizzontale	Frequenza verticale	Modo grafica
1	640× 480	31,5 kHz	60 Hz	VGA
2	640× 480	43,3 kHz	85 Hz	VESA
3	800× 600	46,9 kHz	75 Hz	VESA
4	800× 600	53,7 kHz	85 Hz	VESA
5	1024× 768	60,0 kHz	75 Hz	VESA
6	1024× 768	68,7 kHz	85 Hz	VESA
7	1280× 1024	80,0 kHz	75 Hz	VESA
8	1280× 1024	91,1 kHz	85 Hz	VESA
9	1600× 1200	93,8 kHz	75 Hz	VESA
10	1600× 1200	106,3 kHz	85 Hz	VESA

### Visualizzazione delle informazioni sul monitor

È possibile visualizzare il nome del modello, il numero di serie e l'anno di fabbricazione usando l'indicazione a schermo INFORMAZIONI.

Premere e tenere premuto il tasto  per 3 secondi. Appare l'indicazione a schermo INFORMAZIONI.

Esempio:

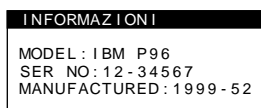

L'indicazione a schermo INFORMAZIONI include il nome del modello, il numero di serie e l'anno di fabbricazione.

L'indicazione a schermo scompare automaticamente dopo circa 30 secondi.

### Messaggi di avvertimento

Se sullo schermo non appare alcuna immagine, apparirà uno dei messaggi descritti di seguito. Per risolvere il problema, vedere la sezione "Guida alla soluzione dei problemi" a pagina 18.

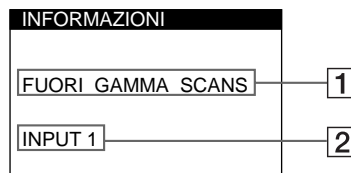

#### 1 Condizioni del segnale di ingresso

##### FUORI GAMMA SCANS

indica che il segnale di ingresso non viene supportato dalle caratteristiche tecniche del monitor.

##### NO SEGNALE INGRESSO

indica che non viene immesso alcun segnale.

##### IL MONITOR È IN MODO RISPARMIO ENERGETICO

indica che il computer è nel modo di risparmio energetico.

Questo messaggio viene visualizzato solo quando il computer è nel modo di risparmio energetico e viene premuto un tasto qualsiasi sul monitor.

#### 2 Connettore selezionato

Questo messaggio indica il connettore attualmente selezionato (INPUT 1 o INPUT 2).

## Guida alla soluzione dei problemi

Questa sezione può rivelarsi utile per identificare e risolvere un problema e di conseguenza eliminare la necessità di rivolgersi ad un centro di assistenza tecnica.

Sintomo	Controllare quanto segue
<b>Assenza d'immagine</b>	
Se l'indicatore  non è illuminato	<ul style="list-style-type: none"> <li>Controllare che il cavo di alimentazione sia collegato correttamente.</li> <li>Controllare che l'interruttore di accensione  sia sulla posizione di accensione.</li> </ul>
Se sullo schermo appare il messaggio "NO SEGNALE INGRESSO" o se l'indicatore  è di colore arancio o i colori verde e arancio si alternano	<ul style="list-style-type: none"> <li>Controllare che l'interruttore di accensione del computer sia sulla posizione di accensione.</li> <li>Verificare che l'impostazione dell'interruttore INPUT 1-2 sia corretta (pagina 5).</li> <li>Controllare che il cavo del segnale video sia collegato correttamente e che tutte le spine siano saldamente inserite nelle prese.</li> <li>Assicurarsi che non ci siano piedini piegati o che non siano stati spinti nel connettore di ingresso video.</li> <li>Controllare che la scheda grafica sia inserita completamente nel corretto alloggiamento del bus.</li> </ul>
Se sullo schermo appare "IL MONITOR E IN MODO RISPARMIO ENERGETICO" o se l'indicatore  è di colore arancio o se i colori verde e arancio si alternano	<ul style="list-style-type: none"> <li>Il computer è nel modo di risparmio energetico. Premere un tasto qualsiasi sulla tastiera o muovere il mouse.</li> <li>Controllare che l'interruttore di accensione del computer sia nella posizione di accensione.</li> <li>Controllare che la scheda grafica sia inserita completamente nel corretto alloggiamento del bus.</li> </ul>
Se sullo schermo appare il messaggio "FUORI GAMMA SCANS"	<ul style="list-style-type: none"> <li>Controllare che il campo di frequenza video rientri in quello specificato per il monitor. (Orizzontale: 30 – 107 kHz Verticale: 48 – 120 Hz). Fare riferimento al manuale delle istruzioni del computer per regolare il campo di frequenza video.</li> <li>Se si sta utilizzando un adattatore del cavo del segnale video, controllare che sia corretto.</li> </ul>
Se non viene visualizzato alcun messaggio e l'indicatore  è illuminato in verde o lampeggia nel colore arancio	<ul style="list-style-type: none"> <li>Consultare "Funzione di autodiagnostica" (pagina 20).</li> </ul>
<b>L'immagine non è chiara</b>	<ul style="list-style-type: none"> <li>Controllare il manuale della scheda grafica per la corretta impostazione del monitor.</li> <li>Controllare nel presente manuale che il modo grafico e la frequenza in cui si sta operando siano supportati. Anche se la frequenza rientra nella gamma prevista, alcune schede grafiche potrebbero avere un impulso sincronico troppo piccolo per far sì che il monitor si sincronizzi correttamente.</li> </ul>
<b>Il colore non è uniforme</b>	<ul style="list-style-type: none"> <li>Smagnetizzare il monitor (pagina 11). Se si colloca vicino al monitor un apparecchio generatore di campi magnetici, ad esempio un altoparlante o se si modifica la direzione del monitor, il colore potrebbe non essere uniforme. La funzione di smagnetizzazione consente di smagnetizzare il telaio di metallo del tubo catodico per ottenere un campo neutro per la riproduzione uniforme del colore. Se è necessario un secondo ciclo di smagnetizzazione, per ottenere un migliore risultato attendere per almeno 20 minuti.</li> </ul>
<b>Non è possibile regolare il monitor mediante i tasti sul pannello anteriore ( appare sullo schermo)</b>	<ul style="list-style-type: none"> <li>Se la funzione di bloccaggio dei comandi è impostata su SI, impostarla su NO utilizzando le indicazioni a schermo di OPZIONI (pagina 13).</li> </ul>
<b>Il bianco non è perfetto</b>	<ul style="list-style-type: none"> <li>Regolare la temperatura di colore (pagina 9).</li> </ul>

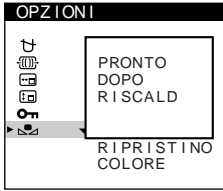
Sintomo	Controllare quanto segue
L'immagine a schermo non è centrata o della dimensione corretta	<ul style="list-style-type: none"> <li>• Premere il tasto  (pagina 5).</li> <li>• Regolare la dimensione o la centratura (pagina 7). Alcuni modi video non riempiono lo schermo fino ai bordi del monitor. Questo problema si manifesta soprattutto con alcune schede grafiche.</li> </ul>
I bordi dell'immagine sono incurvati	<ul style="list-style-type: none"> <li>• Regolare la geometria (pagina 8).</li> </ul>
Le strisce bianche presentano ombre rosse o blu sui bordi	<ul style="list-style-type: none"> <li>• Regolare la convergenza (pagina 10).</li> </ul>
L'immagine è sfuocata	<ul style="list-style-type: none"> <li>• Regolare il contrasto e la luminosità (pagina 6).</li> <li>• Smagnetizzare il monitor (pagina 11). Se si colloca un apparecchio generatore di campi magnetici, ad esempio un altoparlante, vicino al monitor, oppure se si modifica la direzione del monitor, il colore potrebbe non essere uniforme. La funzione di smagnetizzazione consente di smagnetizzare il telaio di metallo del tubo catodico per ottenere un campo neutro per la riproduzione uniforme del colore. Se è necessario un secondo ciclo di smagnetizzazione, per ottenere un migliore risultato attendere per almeno 20 minuti.</li> <li>• Se si riscontrano ombre rosse o blu sui bordi delle immagini, regolare la convergenza (pagina 10).</li> <li>• Selezionare ELIMINA MOIRE e regolare il livello di eliminazione dell'effetto moiré (pagina 12).</li> </ul>
L'immagine salta o ondeggia	<ul style="list-style-type: none"> <li>• Isolare ed eliminare le potenziali origini di campi elettrici o magnetici. Le cause più comuni sono costituite da ventilatori elettrici, illuminazioni fluorescenti, stampanti laser.</li> <li>• Se accanto al presente monitor si trova un secondo monitor, aumentare la distanza fra di essi in modo da ridurre al minimo l'interferenza.</li> <li>• Collegare il monitor ad una diversa presa di rete CA, preferibilmente su un altro circuito.</li> <li>• Collegare il monitor ad un computer completamente diverso, in un'altra stanza.</li> </ul>
L'immagine è tremolante	<ul style="list-style-type: none"> <li>• Impostare il valore della frequenza di refresh per ottenere un'immagine migliore facendo riferimento al manuale per le istruzioni del computer.</li> </ul>
L'immagine appare sdoppiata	<ul style="list-style-type: none"> <li>• Eliminare l'uso di prolunghe del cavo video e/o di cassette di contenimento dell'interruttore del video se si verifica questo problema. Una lunghezza eccessiva del cavo o un collegamento debole possono produrre questo sintomo.</li> </ul>
L'immagine presenta strisce ondulate o ellittiche (effetto moiré)	<ul style="list-style-type: none"> <li>• Selezionare ELIMINA MOIRE e regolare il livello di eliminazione dell'effetto moiré (pagina 12). L'effetto moiré può essere modificato a seconda del computer collegato.</li> <li>• Cambiare la configurazione del motivo del desktop. A causa della relazione fra la risoluzione, il passo dei punti del monitor ed il passo di alcuni tipi di immagine, alcuni sfondi di schermo presentano a volte l'effetto moiré.</li> </ul>
Compaiono due sottili righe orizzontali (cavi)	<ul style="list-style-type: none"> <li>• Questi cavi stabilizzano la griglia di apertura a strisce verticali (pagina 16). La griglia di apertura permette ad un maggiore fascio di luce di penetrare attraverso lo schermo conferendo al tubo catodico Trinitron colori e luminosità superiori.</li> </ul>
Non è possibile attivare la funzione RIPRISTINO COLORE	<ul style="list-style-type: none"> <li>• Per utilizzare questa funzione, il monitor deve essere nel modo di funzionamento normale (indicatore di accensione illuminato in verde) per almeno 30 minuti. Per ulteriori informazioni sull'utilizzo della funzione RIPRISTINO COLORE, vedere "Ripristino del colore" a pagina 13.</li> <li>• Per mantenere il monitor nel modo di funzionamento normale per oltre 30 minuti, regolare le impostazioni del modo di risparmio energetico del computer.</li> <li>• Il monitor potrebbe perdere gradualmente la capacità di eseguire questa funzione a causa dell'usura del cinescopio a colori.</li> </ul>
	
Non appena si accende l'apparecchio si sente un ronzio	<ul style="list-style-type: none"> <li>• Con l'apparecchio acceso, il ciclo di smagnetizzazione automatica è attivato. Durante la fase di smagnetizzazione automatica, si potrebbe udire un ronzio. Lo stesso ronzio si sente quando il monitor viene smagnetizzato manualmente. Questo è normale.</li> </ul>

• Se il problema persiste, contattare l'IBM HelpCenter.

Negli Stati Uniti, chiamare 1-800-772-2227

In Canada, chiamare 1-800-565-3344



• Prendere nota del nome del modello e del numero di serie del monitor. Inoltre prendere nota del produttore, del nome del computer e della scheda grafica.

### Funzione di autodiagnostica

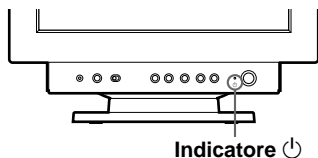
Questo monitor dispone di una funzione di autodiagnostica. Nel caso in cui si verificano problemi al monitor o al computer, lo schermo si oscura e l'indicatore  si illumina in verde oppure lampeggia col colore arancio.



#### Se l'indicatore è verde

- 1 Scollegare il cavo di ingresso video o disattivare il computer collegato.
- 2 Premere due volte il tasto  per spegnere e riaccendere il monitor.
- 3 Premere e tenere premuto per 2 secondi il tasto  prima che il monitor entri nel modo di risparmio energetico.





Se appaiono le quattro barre a colori (bianco, rosso, verde, blu), il monitor funziona in modo appropriato. Ricollegare il cavo di ingresso video e verificare le condizioni del computer.

Se le barre a colori non appaiono, vi è un potenziale guasto al monitor.

Rivolgersi all'IBM HelpCenter e riferire le condizioni di funzionamento del monitor.

#### Se l'indicatore lampeggia col colore arancio

Premere due volte il tasto  per spegnere e riaccendere il monitor.

Se l'indicatore  diventa di colore verde, il monitor funziona in modo appropriato.

Se l'indicatore  continua a lampeggiare, si tratta di un potenziale guasto al monitor. Rivolgersi all'IBM HelpCenter e riferire le condizioni di funzionamento del monitor, annotando il nome del modello e il numero di serie del monitor, nonché la marca e il modello del computer e della scheda video.

### Caratteristiche tecniche

Cinescopio	Griglia di apertura 0,24 mm 19 pollici misurati in diagonale Deflessione di 90°
Area dell'immagine video	365 × 274 mm circa (l/a) Immagine visibile 18,0"
Risoluzione	Orizzontale: 1600 punti max. Verticale: 1200 righe max.
Area dell'immagine standard	352 × 264 mm circa (l/a)
Frequenza di deflessione*	Orizzontale: da 30 a 107 kHz Verticale: da 48 a 120 Hz 256 < Linea Totale < 2048
Tensione/corrente di ingresso CA	da 100 a 240 V, 50 – 60 Hz, Max. 2,0 A
Consumo di energia	Max. 140 W
Temperatura di utilizzo	Da 10°C a 40°C
Dimensioni	462 × 462 × 474 mm circa (l/a/p)
Peso	27 kg circa

\* Condizione di sincronizzazione verticale e orizzontale consigliata

- L'ampiezza della sincronizzazione orizzontale dovrebbe essere superiore a 1,0 µsec.
- L'ampiezza di oscuramento orizzontale dovrebbe essere più di 3,0 µsec.
- L'ampiezza di oscuramento verticale dovrebbe essere più di 450 µsec.

Il design e le caratteristiche tecniche sono soggetti a modifiche senza preavviso.

## Federal Communications Commission (FCC) Statement

This equipment has been tested and found to comply with the limits for a Class B digital device, pursuant to Part 15 of the FCC Rules. These limits are designed to provide reasonable protection against harmful interference in a residential installation. This equipment generates, uses, and can radiate radio frequency energy and, if not installed and used in accordance with the instructions, may cause harmful interference to radio communications. However, there is no guarantee that interference will not occur in a particular installation.

If this equipment does cause harmful interference to radio or television reception, which can be determined by turning the equipment off and on, the user is encouraged to try to correct the interference by one or more of the following measures:

- Reorientate or relocate the receiving antenna.
- Increase the separation between the equipment and receiver.
- Connect the equipment into an outlet on a circuit different from that to which the receiver is connected.
- Consult an IBM authorized dealer or service representative for help.

Properly shielded and grounded cables and connectors must be used in order to meet FCC emission limits. Proper cables and connectors are available from IBM authorized dealers. IBM is not responsible for any radio or television interference caused by using other than recommended cables and connectors or by unauthorized changes or modifications to this equipment. Unauthorized changes or modifications could void the user's authority to operate the equipment.

### Declaration of Conformity

Trade name:	IBM Corporation
Model No.:	6551-23N, 6551-33N, 6551-23S, 6551-63N, 6551-73N, 6551-63S
Responsible Party:	Sony Electronics Inc.
Address:	1 Sony Drive, Park Ridge, NJ. 07656, U.S.A.
Telephone No.:	201-930-6972

This Device complies with Part 15 of the FCC Rules. Operation is subject to the following two conditions: (1) This device may not cause harmful interference, and (2) this device must accept any interference received, including interference that may cause undesired operation.

## Power Cords

For your safety, IBM provides a power cord with a grounded attachment plug to use with this IBM product. To avoid electrical shock, always use the power cord and plug with a properly grounded power outlet.

IBM power cords used in the United States and Canada are listed by the Underwriters Laboratories (UL) and certified by the Canadian Standards Association (CSA).

For units intended to be operated at 115 volts: Use a UL listed and CSA certified cord set consisting of a minimum 18 AWG, type SVT or SJT, three conductor cord, a maximum of 4.5 metres (15 feet) in length and a parallel blade, grounding type attachment plug rated 15 amperes, 125 volts.

For units intended to be operated at 230 volts (U.S. use): Use a UL listed and CSA certified cord set consisting of a minimum 18 AWG, type SVT or SJT, three conductor cord, a maximum of 4.5 metres (15 feet) in length and a tandem blade, grounding type attachment plug rated 15 amperes 250 volts.

For units intended to be operated at 230 volts (outside the U.S.): Use a cord set with a grounding type attachment plug rated 13 amperes (minimum), 250 volts. The cord set should be marked <HAR> and have the appropriate safety approvals for the country in which the equipment will be installed.



As an ENERGY STAR Partner, IBM Corporation has determined that this product meets the ENERGY STAR guidelines for energy efficiency.



This monitor complies with TCO'95 guidelines.

Models: 6551-63N  
6551-73N  
6551-63S



This monitor complies with TCO'99 guidelines.

Models: 6551-23N  
6551-33N  
6551-23S

この装置は、情報処理装置等電波障害自主規制協議会(VCCI)の基準に基づくクラスB情報技術装置です。この装置は、家庭環境で使用することを目的としていますが、この装置がラジオやテレビジョン受信機に近接して使用されると、受信障害を引き起こすことがあります。

取扱説明書に従って正しい取り扱いをしてください。

## **MPRII**

This product complies with Swedish National Council for Metrology (MPR) standards issued in December 1990 (MPRII) for very low frequency (VLF) and extremely low frequency (ELF).

## **Hinweise**

Gemäß der Amtsblätter des BMPT Nm. 61/1991 und 6/1992 wird der Betreiber darauf aufmerksam gemacht, daß die von ihm mit diesem Gerät zusammengestellte Anlage auch den technischen Bestimmungen dieser Amtsblätter genügen muß.

Aus ergonomischen Gründen wird empfohlen, die Grundfarbe Blau nicht auf dunklem Untergrund zu verwenden (schlechte Erkennbarkeit, Augenbelastung bei zu geringem Zeichenkontrast).

Aus ergonomischen Gründen sollten nur Darstellungen auf dunklem Hintergrund bei Vertikalfrequenzen ab 60 Hz (ohne Zeilensprung) benutzt werden.

Die Konvergenz des Bildes kann sich auf Grund des Magnetfeldes am Ort der Aufstellung aus der korrekten Grundeinstellung verändern. Zur Korrektur empfiehlt es sich deshalb, die Regler an der Frontseite für H STAT und V STAT so einzustellen, daß die getrennt sichtbaren Farblinien für Rot, Grün und Blau bei z.B. der Darstellung eines Buchstabens zur Deckung (Konvergenz) gelangen. Siehe hierzu auch die Erklärungen zu H STAT und V STAT.

## **NOM**

IBM de México, S.A.

IBM P96 Monitor de Color (M/T 6551)

Planta de Manufactura

6 Aza-Ikejiri, Oaza-Takada,

Ichinomiya-shi, Aichi-ken,

492 Japan

Hecho en Japón

**NOM - 018**

Consumo de Corriente 2.0 A

Frecuencia de Operacion 50 - 60 Hz

Rension de Alimentacion 100 - 240 V

## **Industry Canada Compliance Statement**

This Class B digital apparatus meets the requirements of the Canadian Interference-Causing Equipment Regulations.

Cet appareil numérique de la classe B respecte toutes les exigences du Règlement sur le matériel Brouilleur du Canada.

## European Union (EU) Statement

This product has been tested and found to comply with the limits for Class B Information Technology Equipment according to CISPR 22 / European Standard EN 55022. The limits for Class B equipment were derived for typical residential environments to provide reasonable protection against interference with licensed communication devices.

Properly shielded and grounded cables and connectors must be used in order to reduce the potential for causing interference to radio and TV communications and to other electrical or electronic equipment. Such cables and connectors are available from IBM authorised dealers.

In accordance with EN 50082-1 1992, Performance Criterion A., it should be noted that in the presence of certain electromagnetic fields, some screen jitter may be observed.

## Spécifications de la CEE

Ce produit a été testé et déclaré conforme aux limites de la Classe B définies pour les équipements informatiques conformément à la norme européenne CISPR 22/EN 55022. Les limites imposées aux équipements de Classe B visent à garantir une protection raisonnable, dans des environnements résidentiels, contre toute interférence avec des équipements de communication agréés.

Des câbles blindés et correctement reliés à la terre doivent être utilisés pour réduire les risques d'interférence avec des communications radio et télévisées, ainsi qu'avec des équipements électriques ou électroniques. Ces câbles et connecteurs sont disponibles auprès de vos revendeurs IBM agréés.

Conformément à la norme EN 50082-1 1992, Performance Criterion A, veuillez noter qu'en présence de certains champs électromagnétiques l'image de l'écran peut être instable.

## Erklärung für die Europäische Union (EU)

Dieses Produkt wurde getestet, und dabei wurde festgestellt, daß es gemäß CISPR 22 / Europäische Norm EN 55022 die Grenzwerte für Ausrüstung der Informationstechnik, Klasse B, einhält. Die Grenzwerte für Ausrüstung der Klasse B wurden für eine typische Wohnumgebung erarbeitet, um einen angemessenen Schutz vor Störungen im Zusammenhang mit zugelassenen Kommunikationsgeräten zu gewährleisten.

Es sind ordnungsgemäß abgeschirmte und geerdete Kabel und Stecker zu verwenden, um das Störungspotential in bezug auf Radio- und Fernsehempfang oder andere elektrische oder elektronische Geräte zu reduzieren. Solche Kabel und Stecker sind bei autorisierten IBM-Fachhändlern erhältlich.

In Übereinstimmung mit EN 50082-1 1992, Leistungskriterium A wird darauf hingewiesen, daß bestimmte elektromagnetische Felder ein Flattern auf dem Bildschirm hervorrufen können.

## Declaración de la Unión Europea (UE)

Este producto ha sido probado y cumple con las limitaciones estipuladas para la Clase B ITE (Information Technology Equipment), de conformidad con CISPR 22 / Estándar Europeo EN 55022. Las limitaciones de los equipos de Clase B se establecieron para que los entornos residenciales típicos a fin de proporcionar una protección razonable contra interferencias con dispositivos de comunicación autorizados.

Se deben utilizar conectores y cables debidamente protegidos y conectados a tierra a fin de reducir las posibilidades de que se produzcan interferencias con comunicaciones por radio o televisión y otros equipos eléctricos o electrónicos. Este tipo de cables y conectores pueden adquirirse en concesionarios autorizados de IBM.

De acuerdo con la norma EN 50082-1 1992, Performance Criterion A, habría que destacar que en presencia de determinados campos electromagnéticos, podría observarse una marcada inestabilidad e la imagen.

## Dichiarazione di conformità dell'Unione Europea (UE)

Questo prodotto è stato collaudato e trovato conforme ai limiti di Classe B relativi agli apparecchi informatici secondo quanto dispone la normativa europea CISPR 22 / EN 55022. I limiti degli apparecchi di Classe B sono stati definiti per i normali ambienti domestici al fine di fornire un'adeguata protezione con dispositivi di comunicazione autorizzati.

Utilizzare cavi e connettori collegati a terra per ridurre il rischio potenziale di interferenza delle comunicazioni radiotelevisive e di altri apparecchi elettrici o elettronici. I cavi sono disponibili presso i rivenditori autorizzati IBM.

In accordo con quanto previsto nel documento EN 50082-1 1992, Performance Criterion A, è importante sottolineare che in presenza di determinati campi elettromagnetici è possibile che si verifichi un certo tremolio delle immagini.

## Statement of Limited Warranty U.S., Canada and Puerto Rico

The warranties provided by IBM in this Statement of Limited Warranty apply only to Machines you originally purchase for your use, and not for resale, from IBM or your reseller. The term "Machine" means an IBM machine, its features, conversions, upgrades, elements, or accessories, or any combination of them. Unless IBM specifies otherwise, the following warranties apply only in the country where you acquire the Machine. If you have any questions, contact IBM or your reseller.

Machine: P96 M/T 6551  
Warranty Period\*: 3 years.  
\* Contact your place of purchase for warranty service information

### Production Status

Each Machine is manufactured from new parts, or new and used parts. In some cases, the Machine may not be new and may have been previously installed. Regardless of the Machine's production status, IBM's warranty terms apply.

### The IBM Warranty for Machines

IBM warrants that each Machine 1) is free from defects in materials and workmanship and 2) conforms to IBM's Official Published Specifications. The warranty period for a Machine is a specified, fixed period commencing on its Date of Installation. The date on your receipt is the Date of Installation, unless IBM or your reseller informs you otherwise. During the warranty period IBM or your reseller, if authorized by IBM, will provide warranty service under the type of service designated for the Machine and will manage and install engineering changes that apply to the Machine.

For IBM or your reseller to provide warranty service for a feature, conversion, or upgrade, IBM or your reseller may require that the Machine on which it is installed be 1) for certain Machines, the designated, serial-numbered Machine and 2) at an engineering-change level compatible with the feature, conversion, or upgrade. Many of these transactions involve the removal of parts and their return to IBM. You represent that all removed parts are genuine and unaltered. A part that replaces a removed part will assume the warranty service status of the replaced part.

If a Machine does not function as warranted during the warranty period, IBM or your reseller will repair it or replace it with one that is at least functionally equivalent, without charge. The replacement may not be new, but will be in good working order. If IBM or your reseller is unable to repair or replace the Machine, you may return it to your place of purchase and your money will be refunded.

If you transfer a Machine to another user, warranty service is available to that user for the remainder of the warranty period. You should give your proof of purchase and this Statement to that user. However, for Machines which have a life-time warranty, this warranty is not transferable.

### Warranty Service

To obtain warranty service for the Machine, you should contact your reseller or call IBM. In the United States, call IBM at 1-800-772-2227. In Canada, call IBM at 1-800-565-3344. You may be required to present proof of purchase.

IBM or your reseller will provide certain types of repair and exchange service, either at your location or at IBM's or your reseller's service center, to restore a Machine to good working order.

When a type of service involves the exchange of a Machine or part, the item IBM or your reseller replaces becomes its property and the replacement becomes yours. You represent that all removed items are genuine and unaltered. The replacement may not be new, but will be in good working order and at least functionally equivalent to the item replaced. The replacement assumes the warranty service status of the replaced item. Before IBM or your reseller exchanges a Machine or part, you agree to remove all features, parts, options, alterations, and attachments not under warranty service. You also agree to ensure that the Machine is free of any legal obligations or restrictions that prevent its exchange.

You agree to:

1. obtain authorization from the owner to have IBM or your reseller service a Machine that you do not own; and
2. where applicable, before service is provided -
  - a) follow the problem determination, problem analysis, and service request procedures that IBM or your reseller provide,
  - b) secure all programs, data, and funds contained in a Machine, and
  - c) inform IBM or your reseller of changes in a Machine's location.

IBM is responsible for loss of, or damage to, your Machine while it is 1) in IBM's possession or 2) in transit in those cases where IBM is responsible for the transportation charges.



## **Extent of Warranty**

IBM does not warrant uninterrupted or error-free operation of a Machine.

The warranties may be voided by misuse, accident, modification, unsuitable physical or operating environment, improper maintenance by you, removal or alteration of Machine or parts identification labels, or failure caused by a product for which IBM is not responsible.

THESE WARRANTIES REPLACE ALL OTHER WARRANTIES OR CONDITIONS, EXPRESS OR IMPLIED, INCLUDING, BUT NOT LIMITED TO, THE IMPLIED WARRANTIES OR CONDITIONS OF MERCHANTABILITY AND FITNESS FOR A PARTICULAR PURPOSE. THESE WARRANTIES GIVE YOU SPECIFIC LEGAL RIGHTS AND YOU MAY ALSO HAVE OTHER RIGHTS WHICH VARY FROM JURISDICTION TO JURISDICTION. SOME JURISDICTIONS DO NOT ALLOW THE EXCLUSION OR LIMITATION OF EXPRESS OR IMPLIED WARRANTIES, SO THE ABOVE EXCLUSION OR LIMITATION MAY NOT APPLY TO YOU. IN THAT EVENT SUCH WARRANTIES ARE LIMITED IN DURATION TO THE WARRANTY PERIOD. NO WARRANTIES APPLY AFTER THAT PERIOD.

## **Limitation of Liability**

Circumstances may arise where, because of a default on IBM's part or other liability you are entitled to recover damages from IBM. In each such instance, regardless of the basis on which you are entitled to claim damages from IBM (including fundamental breach, negligence, misrepresentation, or other contract or tort claim), IBM is liable only for:

1. damages for bodily injury (including death) and damage to real property and tangible personal property; and 2. the amount of any other actual direct damages or loss, up to the greater of U.S. \$100,000 or the charges (if recurring, 12 months' charges apply) for the Machine that is the subject of the claim.

UNDER NO CIRCUMSTANCES IS IBM LIABLE FOR ANY OF THE FOLLOWING: 1) THIRD-PARTY CLAIMS AGAINST YOU FOR LOSSES OR DAMAGES (OTHER THAN THOSE UNDER THE FIRST ITEM LISTED ABOVE); 2) LOSS OF, OR DAMAGE TO, YOUR RECORDS OR DATA; OR 3) SPECIAL, INCIDENTAL, OR INDIRECT DAMAGES OR FOR ANY ECONOMIC CONSEQUENTIAL DAMAGES (INCLUDING LOST PROFITS OR SAVINGS), EVEN IF IBM OR YOUR RESELLER IS INFORMED OF THEIR POSSIBILITY. SOME JURISDICTIONS DO NOT ALLOW THE EXCLUSION OR LIMITATION OF INCIDENTAL OR CONSEQUENTIAL DAMAGES, SO THE ABOVE EXCLUSION OR LIMITATION MAY NOT APPLY TO YOU.

## **Statement of Limited Warranty, Europe.**

For European warranty terms and conditions refer to enclosed IBM warranty statement Part Number 72H9623.

Référez-vous à la garantie IBM N° de référence 72H9623 pour les conditions de garantie européennes.

Die europäischen Garantiebedingungen finden Sie in der beigegeführten IBM- Gewährleistungserklärung, Teilenummer 72H9623.

Los términos y condiciones de las garantías en Europa se recogen en la declaración de garantía adjunta del número de pieza IBM 72H9623.

Per le condizioni e i termini di garanzia relativi ai paesi europei, consultare l'apposita dichiarazione IBM (numero di matricola 72H9623).

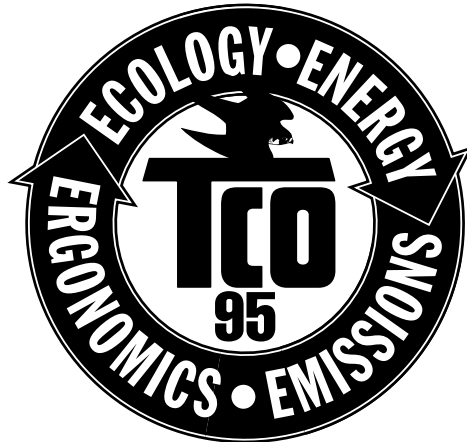

## **Congratulations!**

---

You have just purchased a TCO'95 approved and labelled product! Your choice has provided you with a product developed for professional use. Your purchase has also contributed to reducing the burden on the environment and also, to the further development of environmentally adapted electronics products.

## **Why do we have environmentally labelled computers?**

---

In many countries, environmental labelling has become an established method for encouraging the adaptation of goods and services to the environment. The main problem, as far as computers and other electronics equipment are concerned, is that environmentally harmful substances are used both in the products and during the manufacturing. Since it has not been possible for the majority of electronics equipment to be recycled in a satisfactory way, most of these potentially damaging substances sooner or later enter Nature.

There are also other characteristics of a computer, such as energy consumption levels, that are important from the viewpoints of both the work (internal) and natural (external) environments. Since all methods of conventional electricity generation have a negative effect on the environment (acidic and climate-influencing emissions, radioactive waste, etc.), it is vital to conserve energy. Electronics equipment in offices consume an enormous amount of energy since they are often left running continuously.

## **What does labelling involve?**

---

This product meets the requirements for the TCO'95 scheme which provides for international and environmental labelling of personal computers. The labelling scheme was developed as a joint effort by the TCO (The Swedish Confederation of Professional Employees), Naturskyddsforeningen (The Swedish Society for Nature Conservation) and NUTEK (The National Board for Industrial and Technical Development in Sweden).

The requirements cover a wide range of issues: environment, ergonomics, usability, emission of electrical and magnetic fields, energy consumption and electrical and fire safety.

The environmental demands concern restrictions on the presence and use of heavy metals, brominated and chlorinated flame retardants, CFCs (freons) and chlorinated solvents, among other things. The product must be prepared for recycling and the manufacturer is obliged to have an environmental plan which must be adhered to in each country where the company implements its operational policy.

The energy requirements include a demand that the computer and/or display, after a certain period of inactivity, shall reduce its power consumption to a lower level in one or more stages. The length of time to reactivate the computer shall be reasonable for the user.

Labelled products must meet strict environmental demands, for example, in respect of the reduction of electric and magnetic fields, physical and visual ergonomics and good usability.

On this page, you will find a brief summary of the environmental requirements met by this product. The complete environmental criteria document may be ordered from:

TCO Development Unit

S-114 94 Stockholm

Sweden

Fax: +46 8 782 92 07

Email (Internet): [development@tco.se](mailto:development@tco.se)

Current information regarding TCO'95 approved and labelled products may also be obtained via the Internet, using the address:

<http://www.tco-info.com/>

TCO'95 is a co-operative project between TCO (The Swedish Confederation of Professional Employees), Naturskyddsforeningen (The Swedish Society for Nature Conservation) and NUTEK (The National Board for Industrial and Technical Development in Sweden).

## Environmental Requirements

---

### Brominated flame retardants

Brominated flame retardants are present in printed circuit boards, cables, wires, casings and housings. In turn, they delay the spread of fire. Up to thirty percent of the plastic in a computer casing can consist of flame retardant substances. These are related to another group of environmental toxins, PCBs, which are suspected to give rise to similar harm, including reproductive damage in fish-eating birds and mammals, due to the bio-accumulative\* processes. Flame retardants have been found in human blood and researchers fear that disturbances in foetus development may occur.

TCO'95 demand requires that plastic components weighing more than 25 grams must not contain organically bound chlorine and bromine.

### Lead\*\*

Lead can be found in picture tubes, display screens, solders and capacitors. Lead damages the nervous system and in higher doses, causes lead poisoning.

TCO'95 requirement permits the inclusion of lead since no replacement has yet been developed.

### Cadmium\*\*

Cadmium is present in rechargeable batteries and in the colour-generating layers of certain computer displays. Cadmium damages the nervous system and is toxic in high doses.

TCO'95 requirement states that batteries may not contain more than 25 ppm (parts per million) of cadmium. The colour-generating layers of display screens must not contain any cadmium.

### Mercury\*\*

Mercury is sometimes found in batteries, relays and switches. Mercury damages the nervous system and is toxic in high doses. TCO'95 requirement states that batteries may not contain more than 25 ppm (parts per million) of mercury. It also demands that no mercury is present in any of the electrical or electronics components concerned with the display unit.

### CFCs (freons)

CFCs (freons) are sometimes used for washing printed circuit boards and in the manufacturing of expanded foam for packaging. CFCs break down ozone and thereby damage the ozone layer in the stratosphere, causing increased reception on Earth of ultraviolet light with consequent increased risks of skin cancer (malignant melanoma).

The relevant TCO'95 requirement: Neither CFCs nor HCFCs may be used during the manufacturing of the product or its packaging.

\* Bio-accumulative is defined as substances which accumulate within living organisms

\*\* Lead, Cadmium and Mercury are heavy metals which are Bio-accumulative.

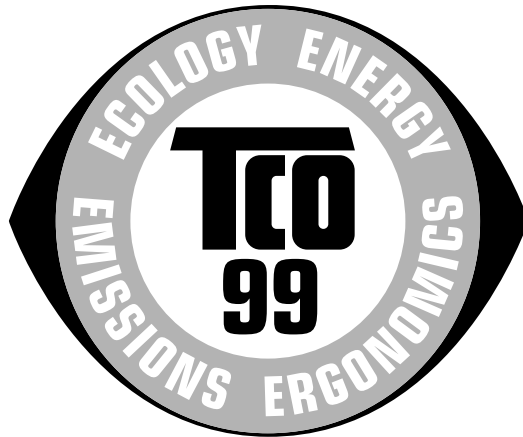

## **Congratulations!**

---

You have just purchased a TCO'99 approved and labelled product! Your choice has provided you with a product developed for professional use. Your purchase has also contributed to reducing the burden on the environment and also to the further development of environmentally adapted electronics products.

## **Why do we have environmentally labelled computers?**

---

In many countries, environmental labelling has become an established method for encouraging the adaptation of goods and services to the environment. The main problem, as far as computers and other electronics equipment are concerned, is that environmentally harmful substances are used both in the products and during their manufacture. Since it is not so far possible to satisfactorily recycle the majority of electronics equipment, most of these potentially damaging substances sooner or later enter nature.

There are also other characteristics of a computer, such as energy consumption levels, that are important from the viewpoints of both the work (internal) and natural (external) environments. Since all methods of electricity generation have a negative effect on the environment (e.g. acidic and climate-influencing emissions, radioactive waste), it is vital to save energy. Electronics equipment in offices is often left running continuously and thereby consumes a lot of energy.

## **What does labelling involve?**

---

This product meets the requirements for the TCO'99 scheme which provides for international and environmental labelling of personal computers. The labelling scheme was developed as a joint effort by the TCO (The Swedish Confederation of Professional Employees), Svenska Naturskyddsforeningen (The Swedish Society for Nature Conservation) and Statens Energimyndighet (The Swedish National Energy Administration).

Approval requirements cover a wide range of issues: environment, ergonomics, usability, emission of electric and magnetic fields, energy consumption and electrical and fire safety.

The environmental demands impose restrictions on the presence and use of heavy metals, brominated and chlorinated flame retardants, CFCs (freons) and chlorinated solvents, among other things. The product must be prepared for recycling and the manufacturer is obliged to have an environmental policy which must be adhered to in each country where the company implements its operational policy.

The energy requirements include a demand that the computer and/or display, after a certain period of inactivity, shall reduce its power consumption to a lower level in one or more stages. The length of time to reactivate the computer shall be reasonable for the user.

Labelled products must meet strict environmental demands, for example, in respect of the reduction of electric and magnetic fields, physical and visual ergonomics and good usability.

Below you will find a brief summary of the environmental requirements met by this product. The complete environmental criteria document may be ordered from:

**TCO Development**

SE-114 94 Stockholm, Sweden

Fax: +46 8 782 92 07

Email (Internet): [development@tco.se](mailto:development@tco.se)

Current information regarding TCO'99 approved and labelled products may also be obtained via the Internet, using the address: <http://www.tco-info.com/>

## Environmental requirements

---

### Flame retardants

Flame retardants are present in printed circuit boards, cables, wires, casings and housings. Their purpose is to prevent, or at least to delay the spread of fire. Up to 30% of the plastic in a computer casing can consist of flame retardant substances. Most flame retardants contain bromine or chloride, and those flame retardants are chemically related to another group of environmental toxins, PCBs. Both the flame retardants containing bromine or chloride and the PCBs are suspected of giving rise to severe health effects, including reproductive damage in fish-eating birds and mammals, due to the bio-accumulative\* processes. Flame retardants have been found in human blood and researchers fear that disturbances in foetus development may occur.

The relevant TCO'99 demand requires that plastic components weighing more than 25 grams must not contain flame retardants with organically bound bromine or chlorine. Flame retardants are allowed in the printed circuit boards since no substitutes are available.

### Cadmium\*\*

Cadmium is present in rechargeable batteries and in the colour-generating layers of certain computer displays. Cadmium damages the nervous system and is toxic in high doses. The relevant TCO'99 requirement states that batteries, the colour-generating layers of display screens and the electrical or electronics components must not contain any cadmium.

### Mercury\*\*

Mercury is sometimes found in batteries, relays and switches. It damages the nervous system and is toxic in high doses. The relevant TCO'99 requirement states that batteries may not contain any mercury. It also demands that mercury is not present in any of the electrical or electronics components associated with the labelled unit.

### CFCs (freons)

The relevant TCO'99 requirement states that neither CFCs nor HCFCs may be used during the manufacture and assembly of the product. CFCs (freons) are sometimes used for washing printed circuit boards. CFCs break down ozone and thereby damage the ozone layer in the stratosphere, causing increased reception on earth of ultraviolet light with e.g. increased risks of skin cancer (malignant melanoma) as a consequence.

### Lead\*\*

Lead can be found in picture tubes, display screens, solders and capacitors. Lead damages the nervous system and in higher doses, causes lead poisoning. The relevant TCO'99 requirement permits the inclusion of lead since no replacement has yet been developed.

\* Bio-accumulative is defined as substances which accumulate within living organisms.

\*\* Lead, Cadmium and Mercury are heavy metals which are Bio-accumulative.

## Service Information

The following parts are for use by IBM service, or IBM authorized dealers, to support customer warranty. Parts are for service use only.

<b>Part No</b>	<b>M/T-Model</b>	<b>Description</b>
04N7192	6551-23N	Monitor UVNH (Pearl White), NA, EMEA
04N7193	6551-33N	Monitor UVNH (Pearl White), JPN
04N7194	6551-63N	Monitor UVNH (Stealth Black), NA, EMEA
04N7195	6551-73N	Monitor UVNH (Stealth Black), JPN
04N7196	6551-23S	Monitor UVSH (Pearl White), ANZ
04N7197	6551-63S	Monitor UVSH (Stealth Black), ANZ
04N7198	6551-23N, 6551-33N, 6551-23S	Tilt/Swivel UVNH (Pearl White), WW
04N7199	6551-63N, 6551-73N, 6551-63S	Tilt/Swivel UVNH (Stealth Black), WW



© Copyright IBM Corporation.  
All rights reserved.  
International Business Machines Corporation  
New Orchard Road, Armonk, NY 10504

Printed in Japan

3-868-265-12 (1)

P96 User Guide Part Number 04N7204  
EC D03437

